

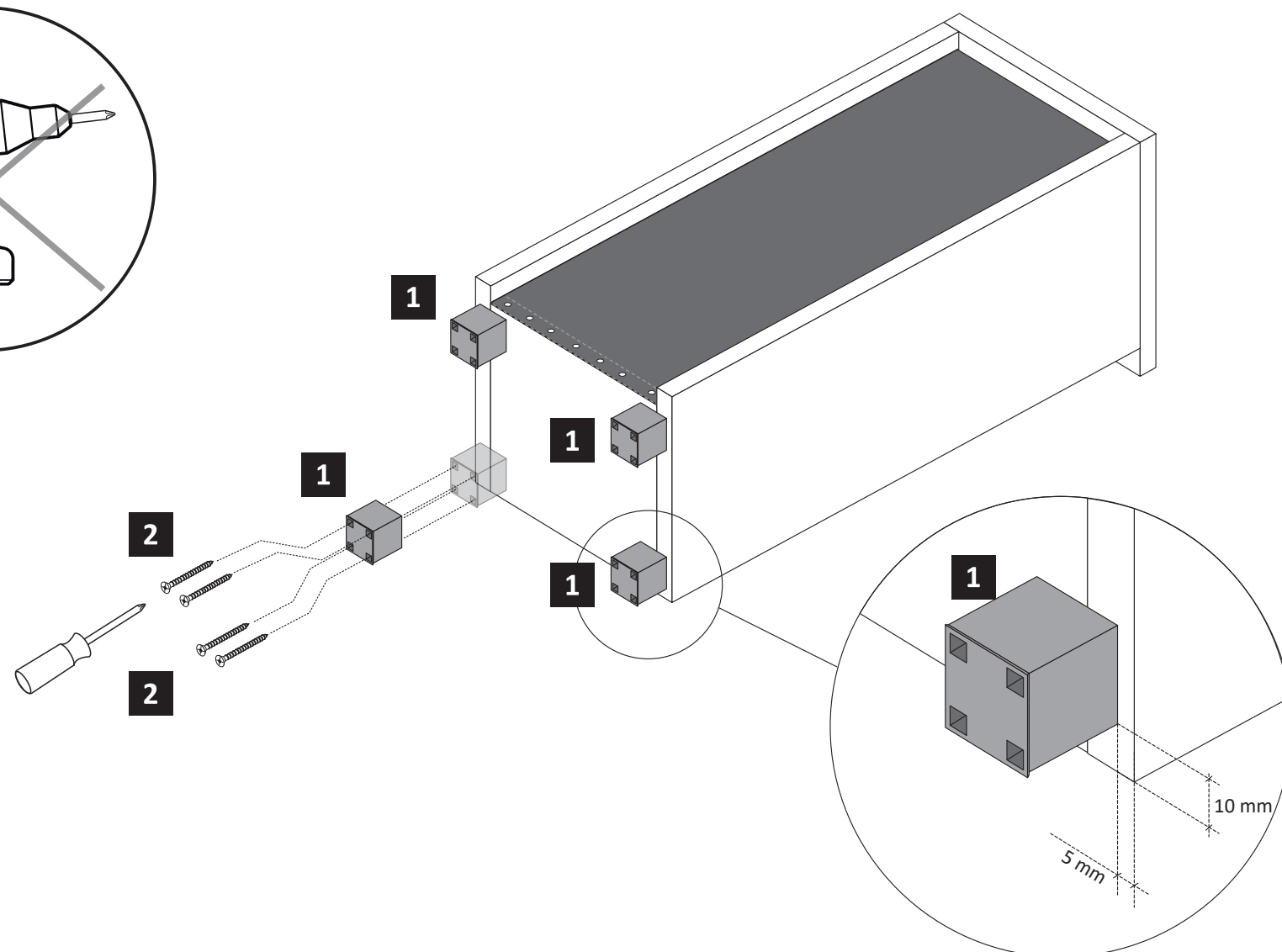

89931.330

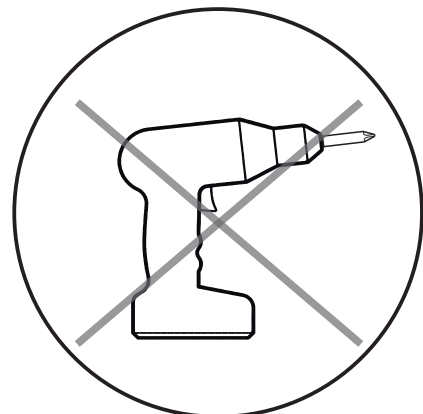
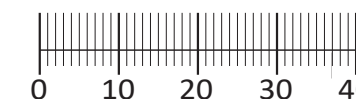
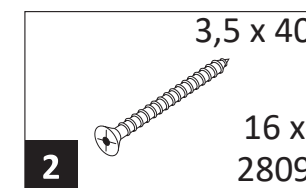
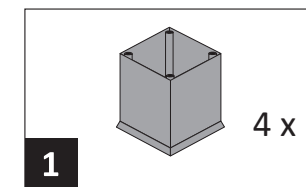
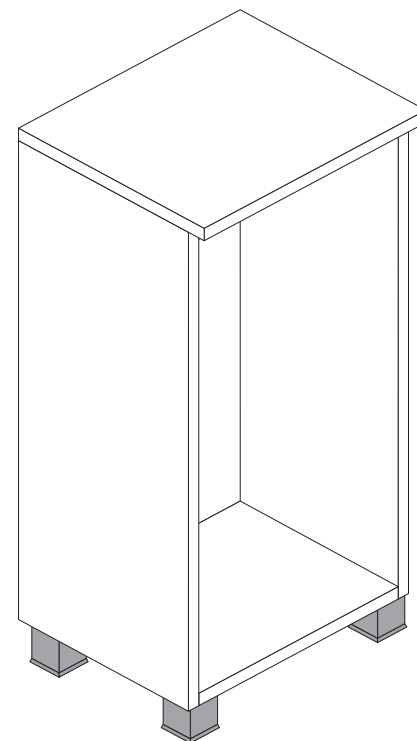
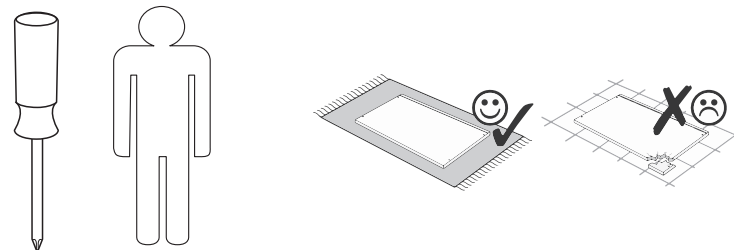

ACHTUNG !

Nutzen Sie die Schablone zum Ankören auf der Schrankunterseite, für die Fußmontage.

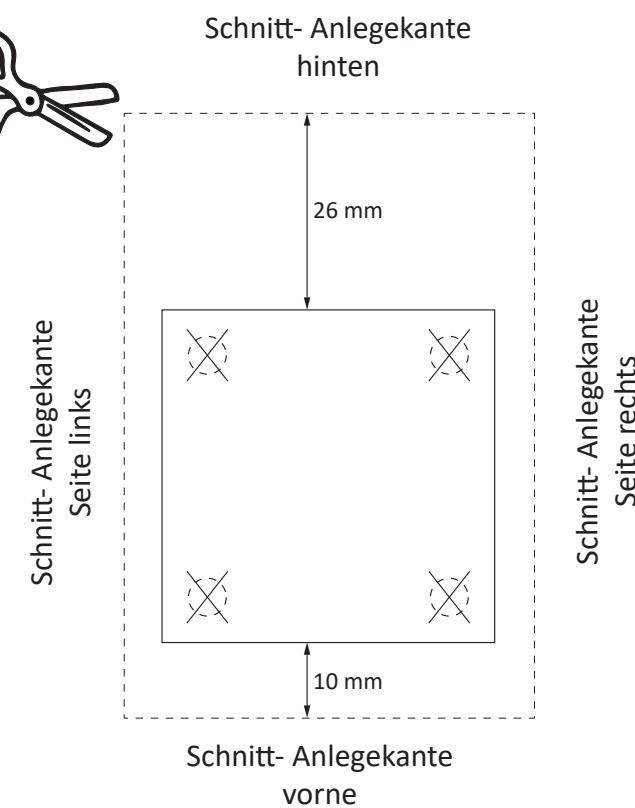



Artikel-Nr.	Aufbauanleitungs-Nr.	Fertigungsdatum
	88152.330	

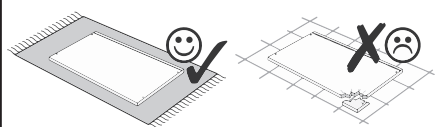
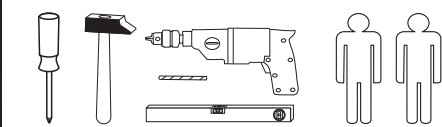
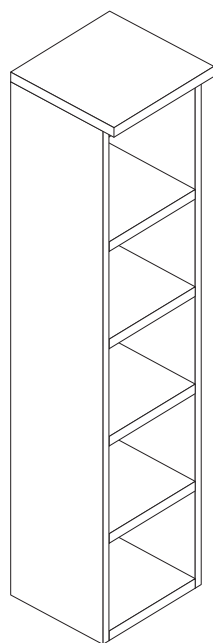

1 8 x 2802 8 x	2 8 x 2801 8 x	3 8 x 30 8 x	4 5/5 x 16 16 x	5 Leim 1 x
6 15 x 2862 15 x	7 4 x 27 2 x	8 4 x 30 4 x	9 5,8 x 55 2 x	10 8 x 30 2 x
11 2 x 2843.1 2 x	12 6 x 2552 6 x	13 3,5 x 15 2 x	14 4 x 9 4 x	A 5 x 30 2 x

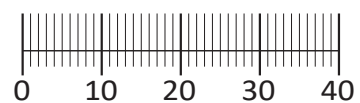

Held Möbel GmbH
Vogelparadies 9
32457 Porta Westfalica
Mail:
info@held-moebel.de

Diese Aufbauanleitung muss bis zum Ende der Nutzungszeit ihres Produktes sorgfältig aufbewahrt werden! Im Rahmen des Produkthaftungsgesetzes müssen Sie die Herstellerkennzeichnung aufbewahren. Zusätzlich kann Ihnen die Aufbauanleitung bei Ersatzteilbestellungen helfen, Bauteile und Beschläge eindeutig zu identifizieren.

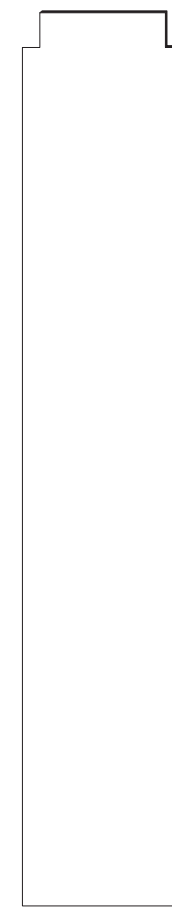
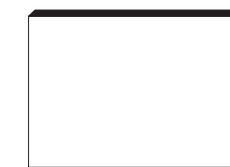
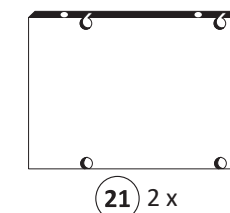
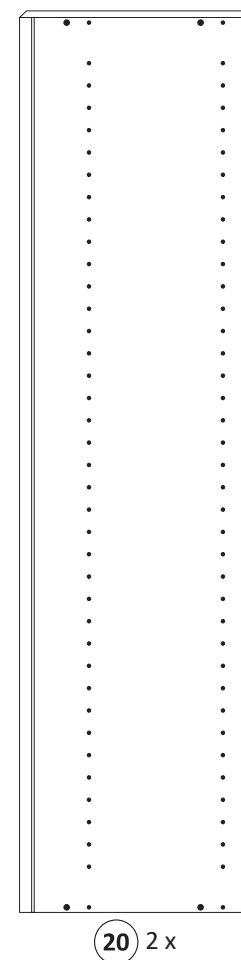

1

1 8 x 2802 8 x	4 5/5 x 16 16 x	8 4 x 30 4 x	11 2 x 2843.1 2 x
-----------------------------	------------------------------	---------------------------	--------------------------------

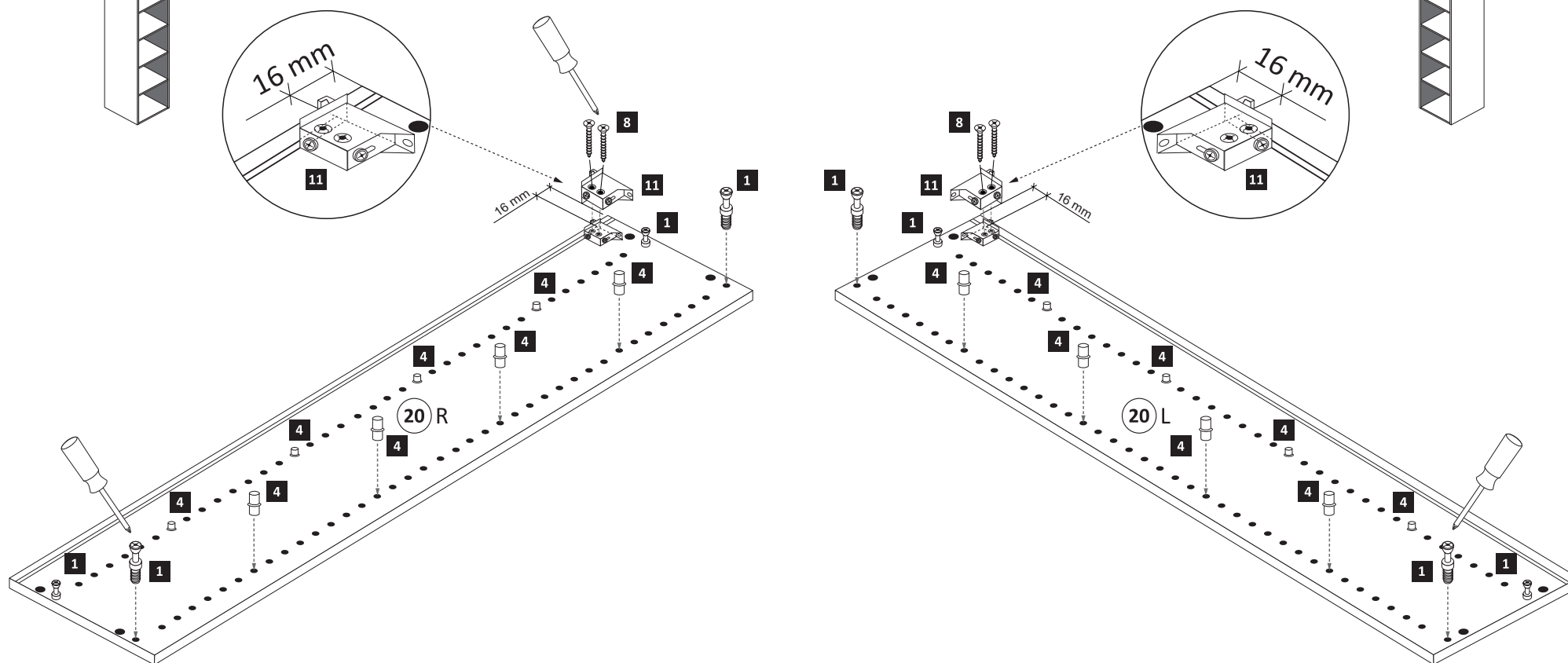

2

2 8 x 2801 8 x	3 8 x 30 8 x	5 Leim 1 x
-----------------------------	---------------------------	-------------------------

