

Filia

1/4 tournant - avec barreaux verticales

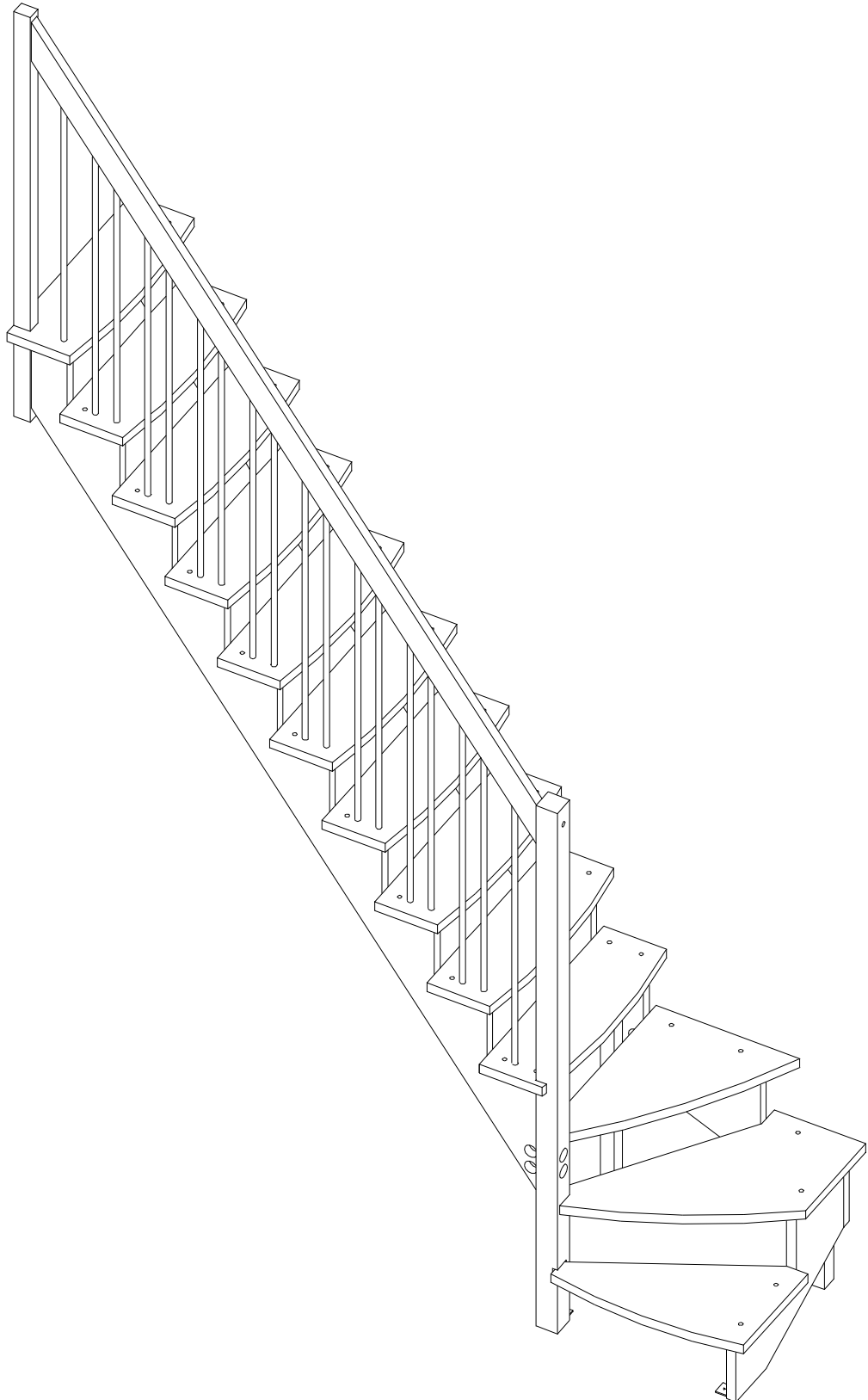

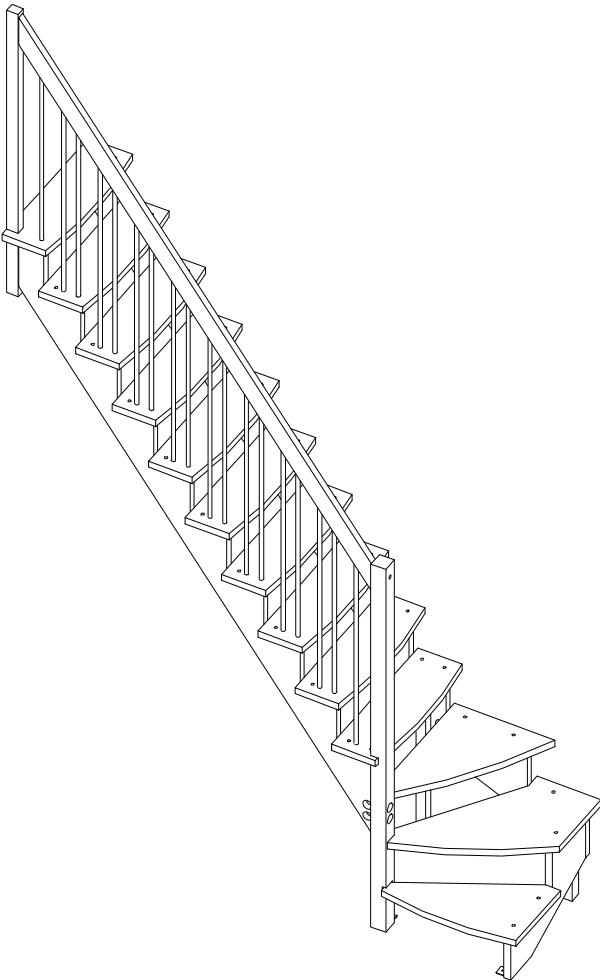





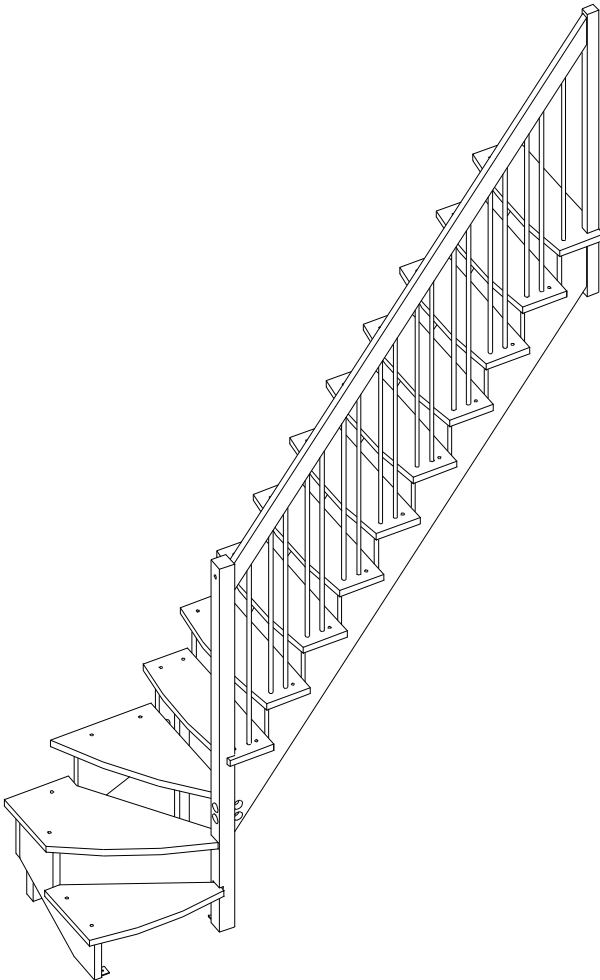

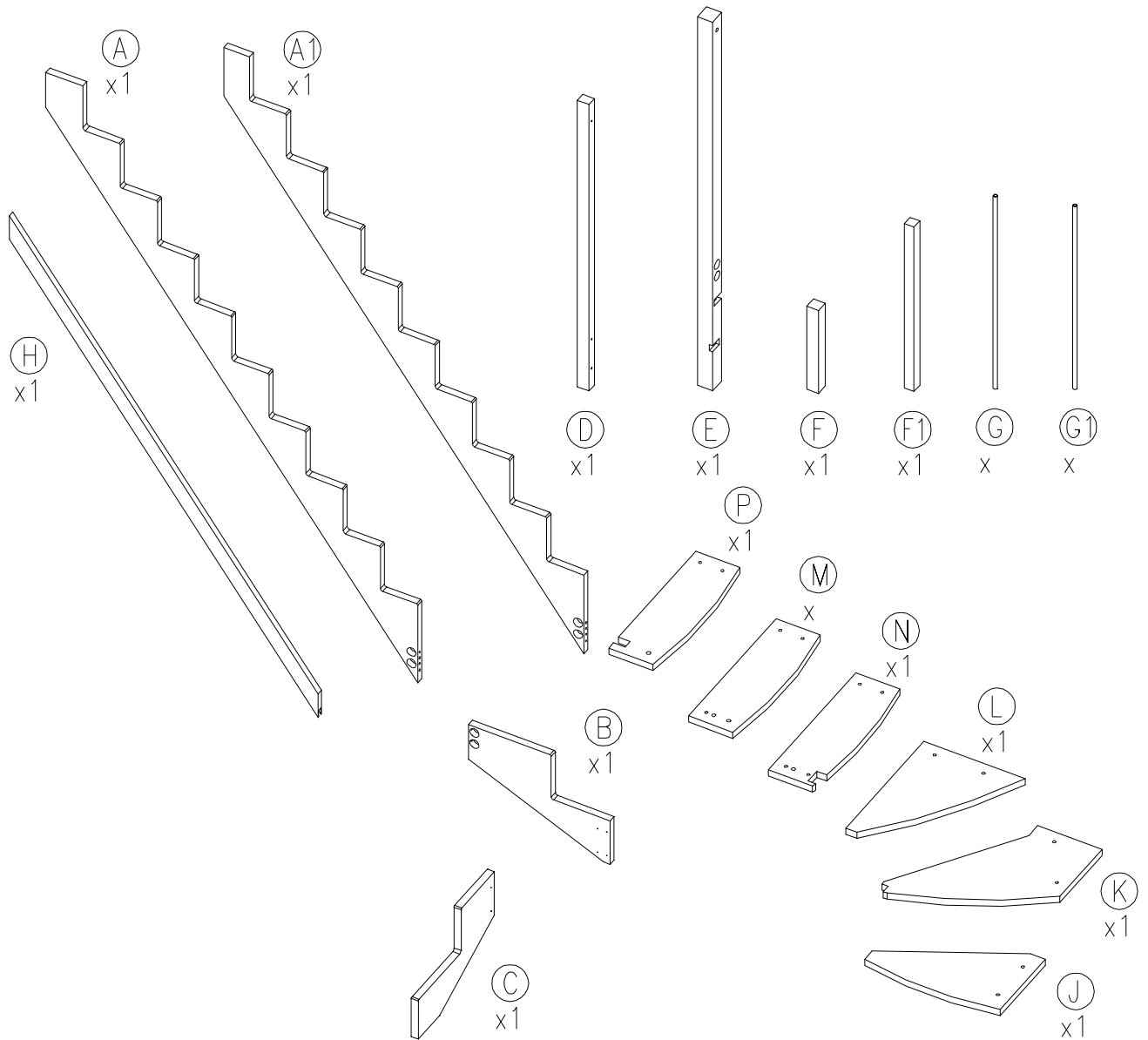









Garde-corps à gauche



Garde-corps à droite





 ① x4 6x50	 ② x4 10x50	 ③ x8 4,5x20	 ④ x2 $\varnothing 8 \times 55$	 ⑤ x6	 ⑥ x6 M8	 ⑦ x14 6x70	 ⑧ x2 $\varnothing 8 / \varnothing 24$
 ⑨ x3 $\varnothing 16$	 ⑩ x36 $\varnothing 12$	 ⑪ x45 5x50	 ⑫ x8 $\varnothing 40$	 ⑬ x2 M8x70	 ⑭ x4	⑮	⑯
 ⑰ x1	 ⑱ x6 $\varnothing 8$	 ⑲ x4 $\varnothing 10$	 ⑳ x1	㉑	㉒	㉓	㉔

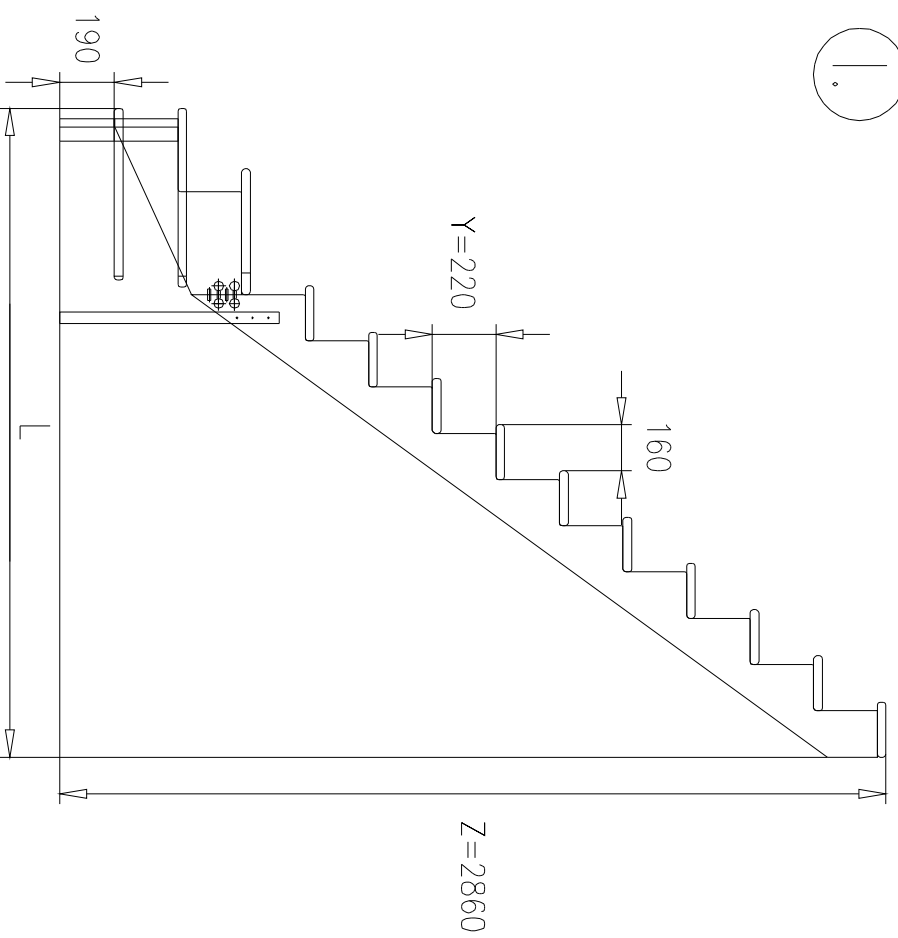
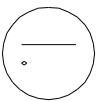

Y	Z Höhe
22.0 cm	
Marche	Y
11	242.0 cm
12	264.0 cm
13	286.0 cm

Y	L Portée	
22.0 cm	65.0 cm	75.0 cm
Marche	Y	Z
11	191.3	201.3
12	207.3	217.3
13	223.3	233.3

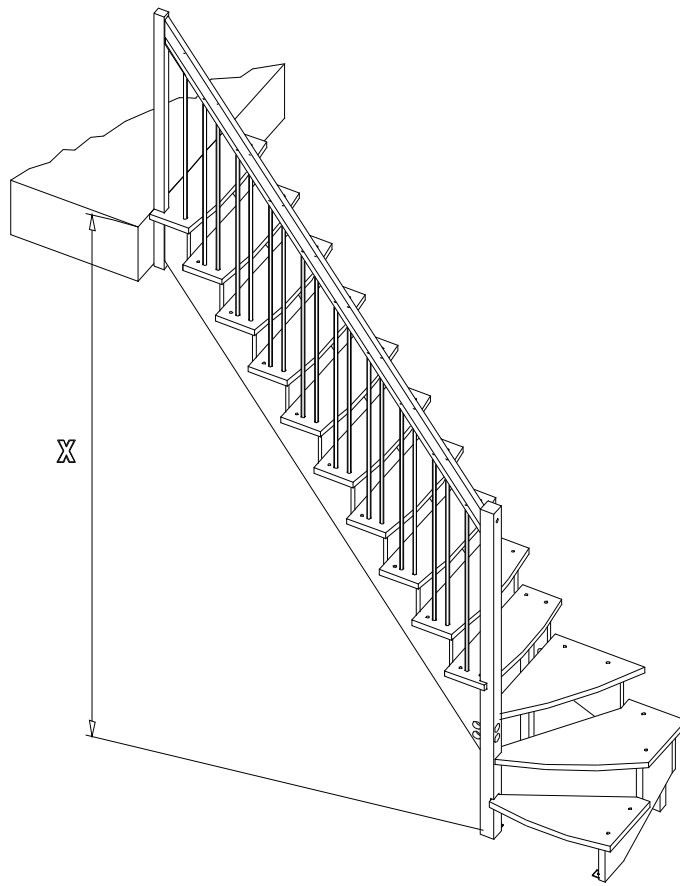

Z·X=T

X

1

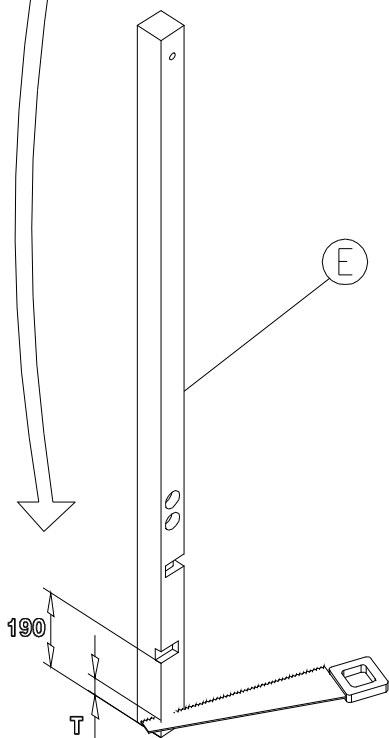

2

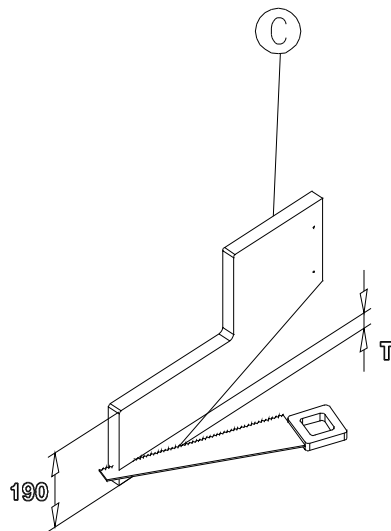

3

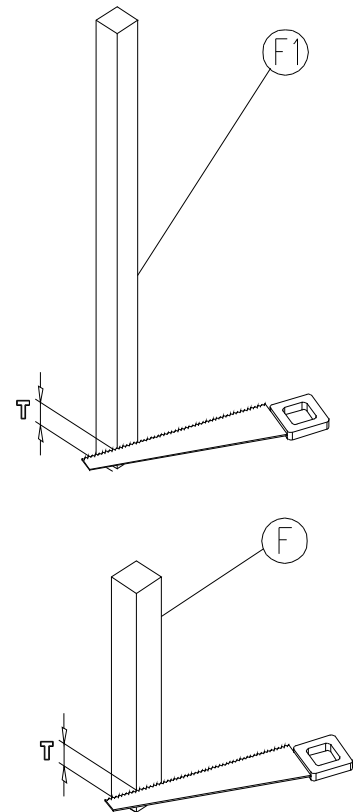

4

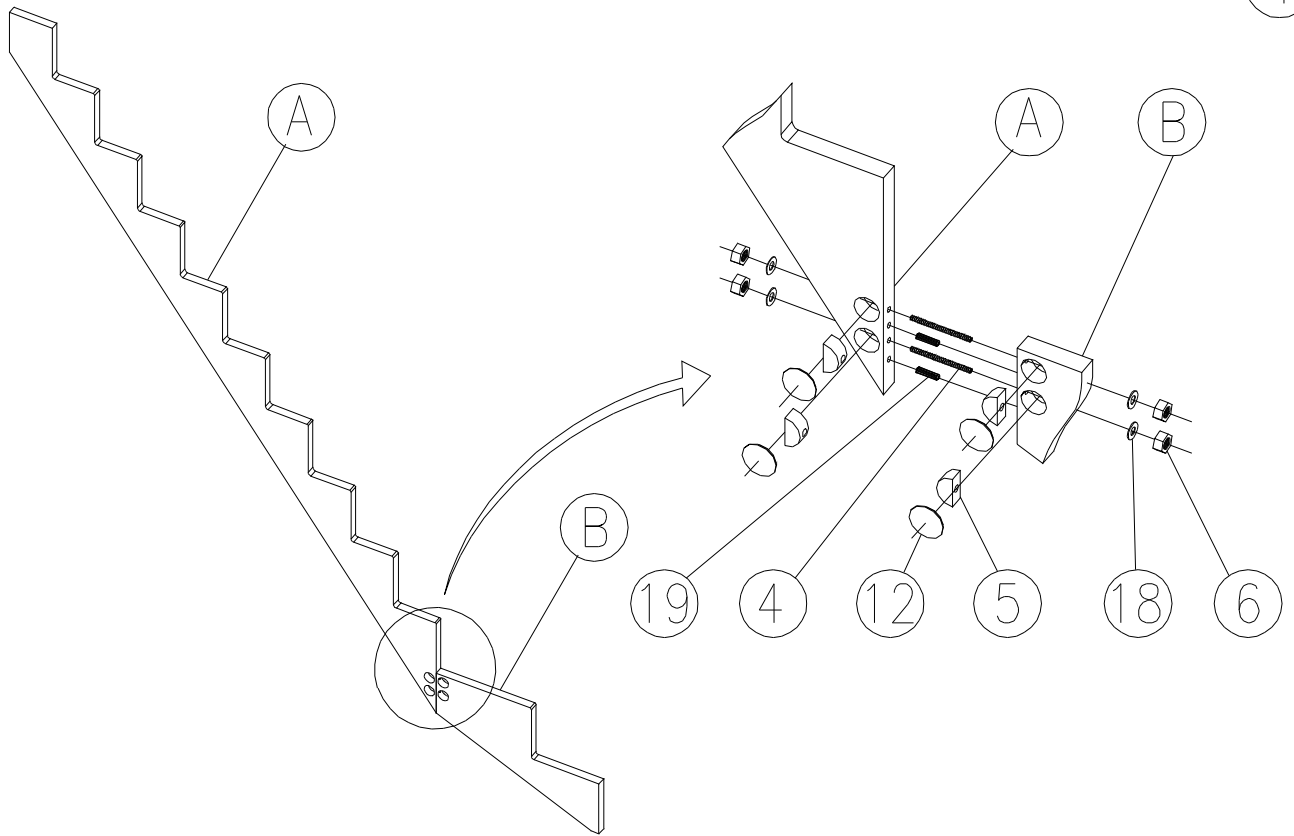

5

