

Alena

Maße

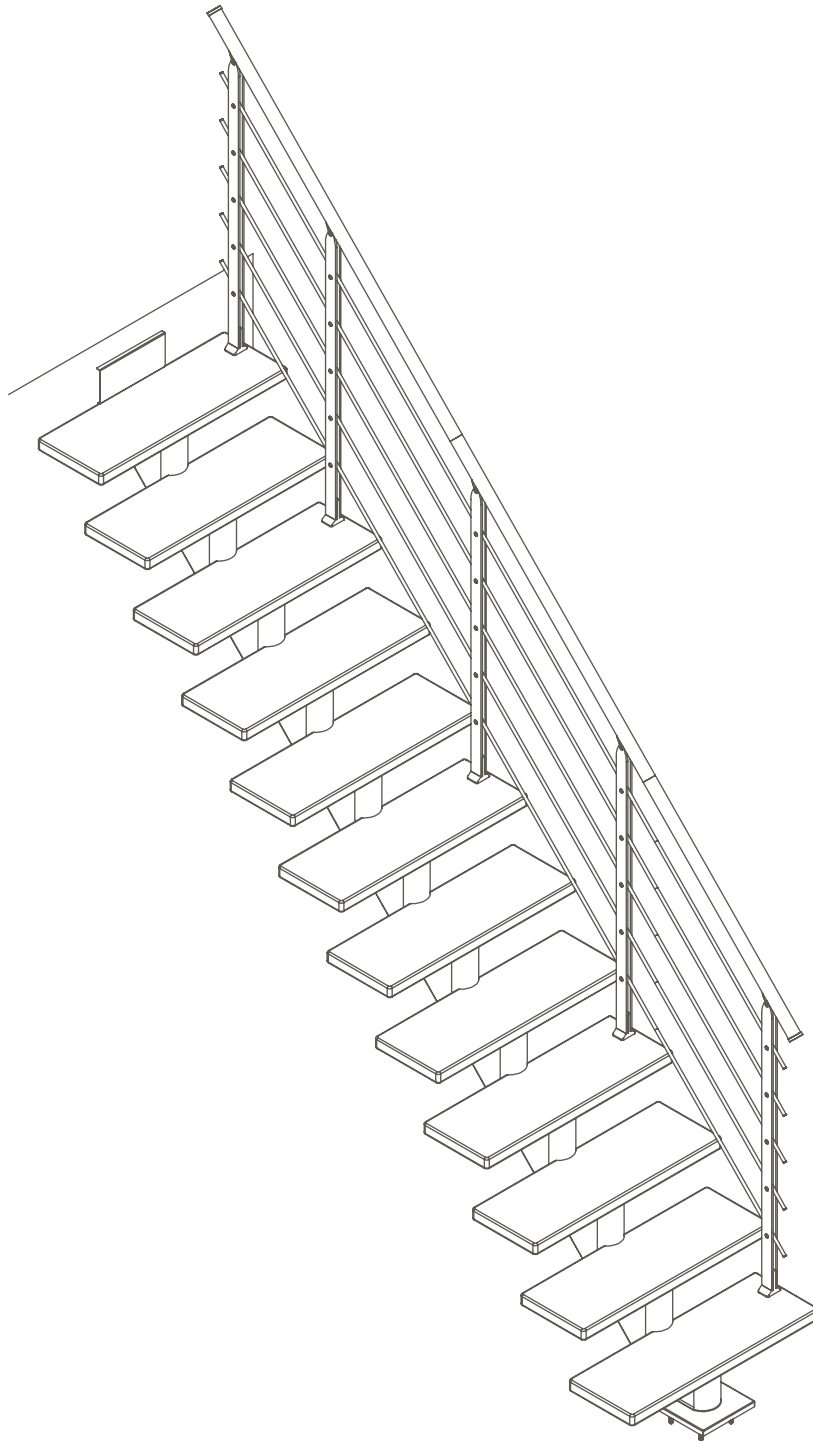

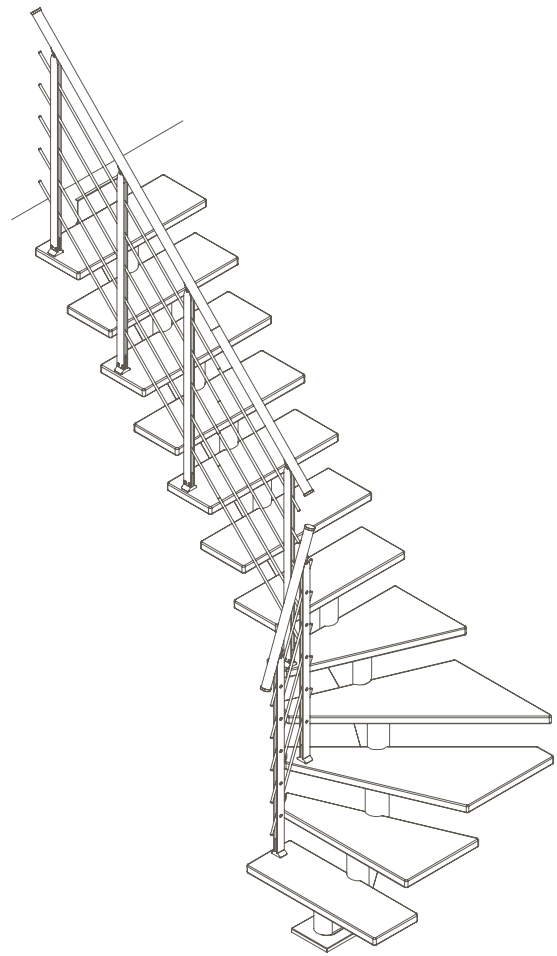

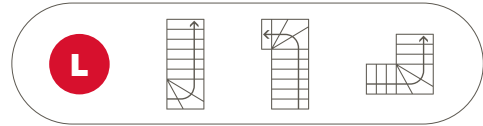
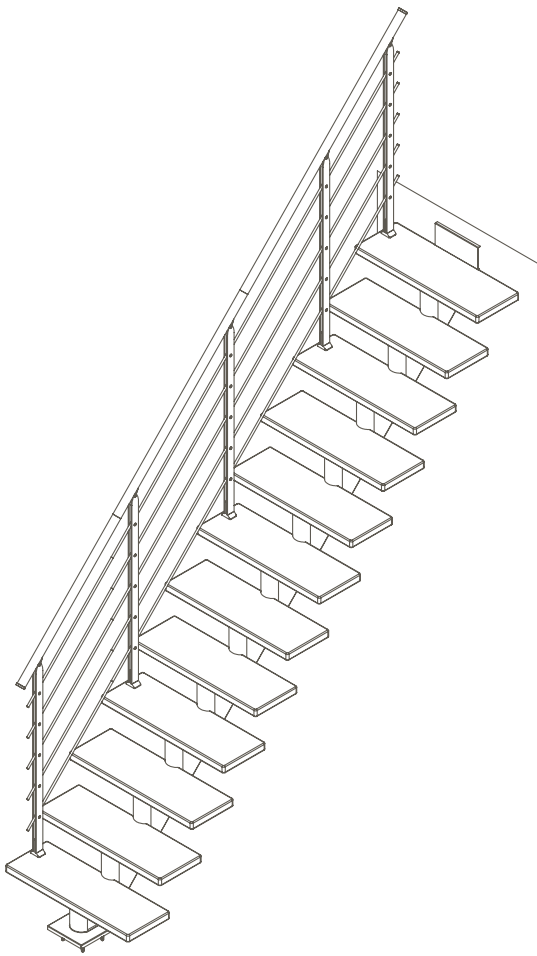
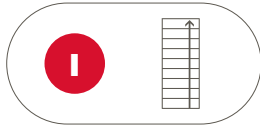
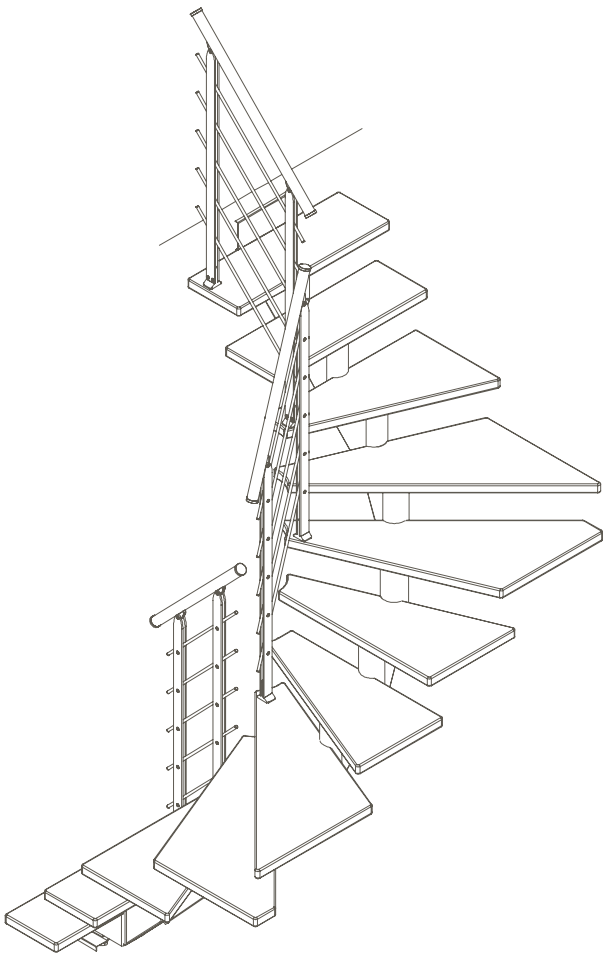

Video: www.dolle.de/Alena

BEZEICHUNGEN





C1

E

G

H

M

	Staircase width w. 1 banister	Headroom	Going (of tread)	Height floor-to-floor	Upper floor opening length - min.
	Escalier à 1 rampe	Echappée	Giron	Hauteur sol-sol	Longueur de trémie min.
	Trappe bredde m. 1 gelænder	Frihøjde	Grund	Etagehøjde	Hulmål længde min.
	Trappbredd med 1 räcke	Frihöjd	Grund	Golv till golv höjd	Hålmått längd min.
	Treppenbreite inkl. 1 Geländer	Kopffreiheit	Auftrittsbreite	Geschosshöhe	Öffnungsgröße länge min.





N

O

P

R

R1

	Upper floor opening width - min.	Clear width	Pitch	Total going length	Total going width
	Largeur de trémie min.	Largeur utile	Pente de l'escalier	Recul total - longueur	Recul total - largeur
	Hulmål bredde min.	Fri bredde	Stjghed/hældning	Udladning længde	Udladning bredde
	Hålmått bredd min.	Fri bredd	Hällning	Trapplängd	Trappbredd
	Öffnungsgröße breite min.	Durchgangsmaß	Winkel	Ausladung länge	Ausladung breite

S

T

V

W

X

	Rise height	Number of treads	Tread depth	Tread width	Tread thickness
	Hauteur de marche	Nombre de marches	Profondeur de marche	Largeur de marche	Epaisseur de marche
	Stigningshøjde	Antal trin	Trin dybde	Trin bredde	Trin tykkelse
	Stigningshöjd	Antal steg	Stegdjup	Stegbredd	Stegtjocklek
	Steigungshöhe	Anzahl Stufen	Stufen tiefe	Stufen breite	Stufen Stärke

Z

	Deck thickness
	Epaisseur de dalle
	Dæk tykkelse
	Bjälklagstjocklek
	Deckenstärke

MASSE

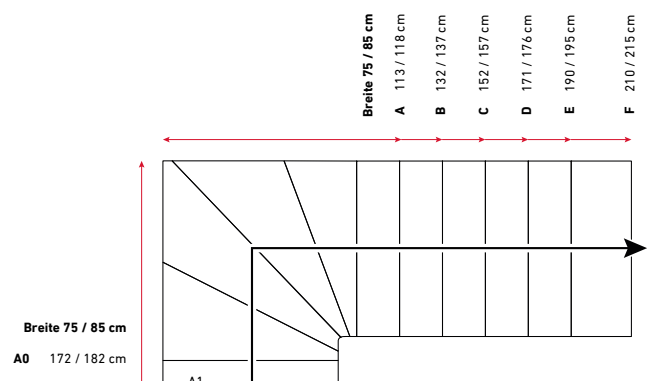
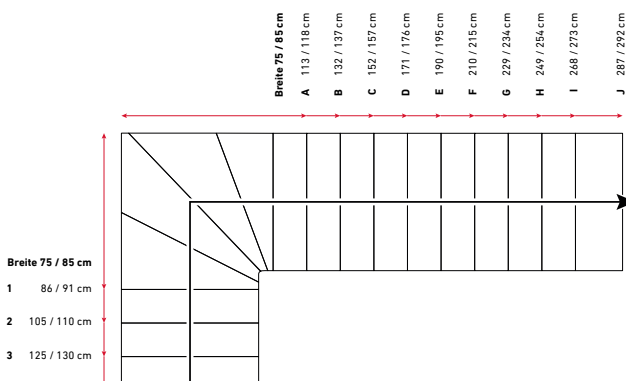
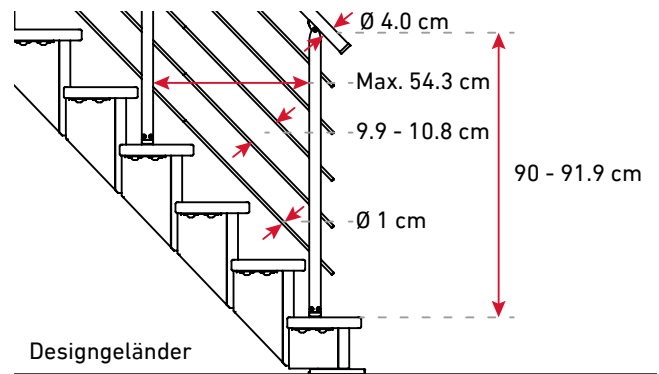
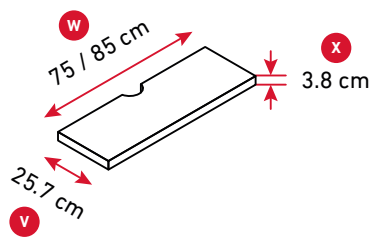
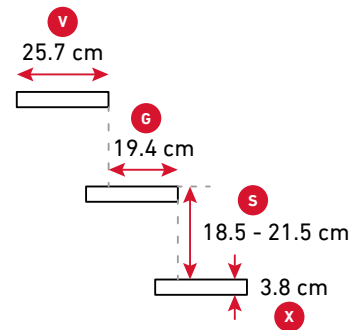
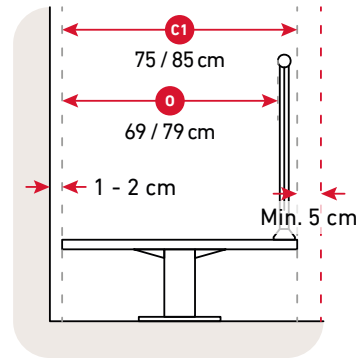
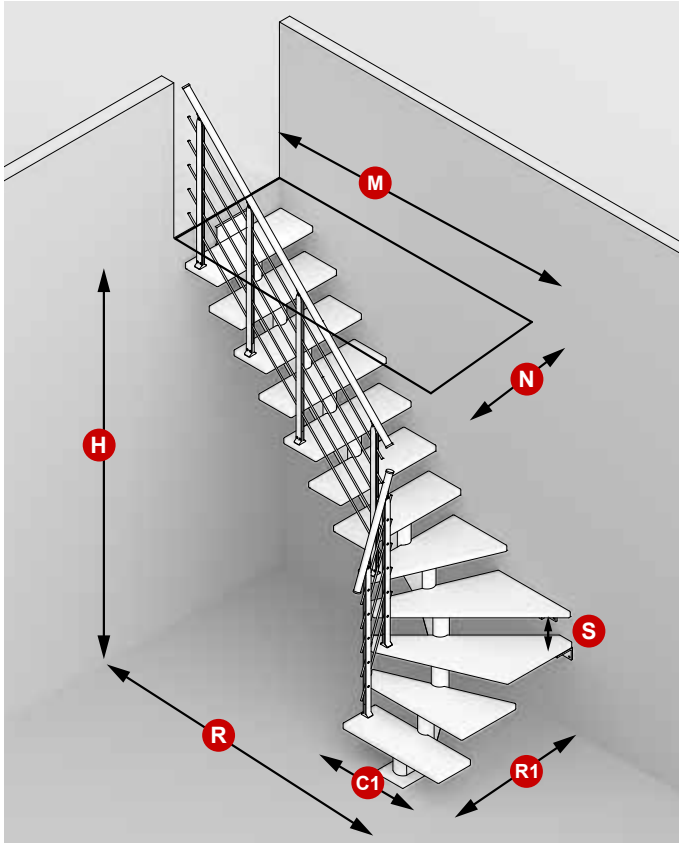

MASSE

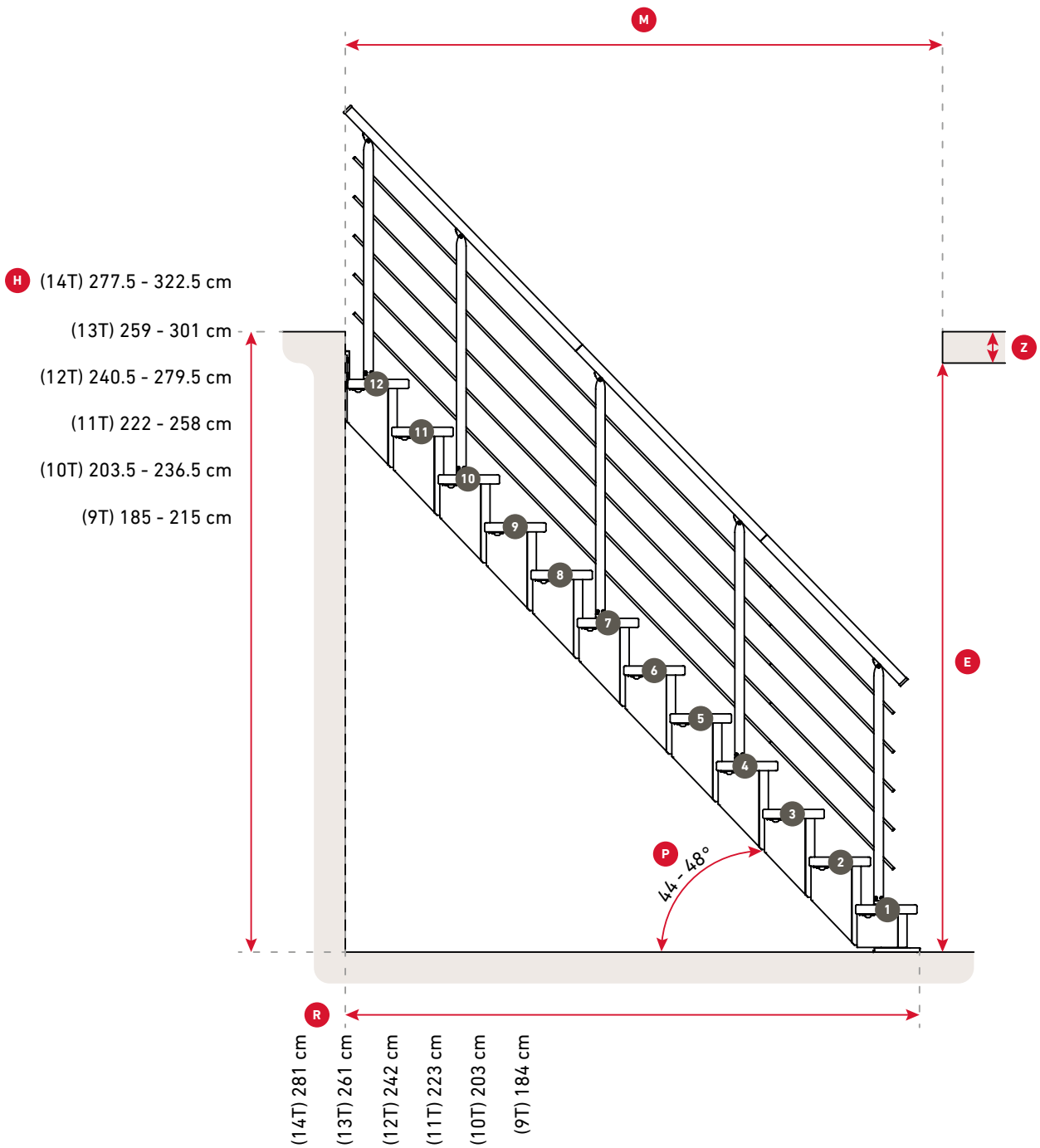

ALENA 11 STUFEN – BREITE 75 CM

H 222 - 258 cm

Treppenmaße inkl. einseitigem Designgeländer

Die Größe der Deckenöffnung in diesen Beispielen basiert auf den Annahmen: 2 cm Abstand zur Wand, 5 cm Abstand für die Hand, 19 cm Steigungshöhe, 25 cm Deckenstärke, 200 cm Kopfhöhe.

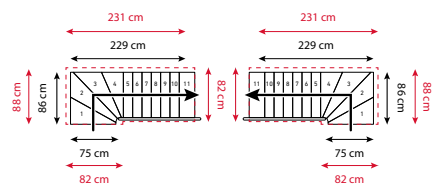
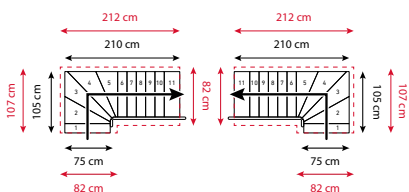
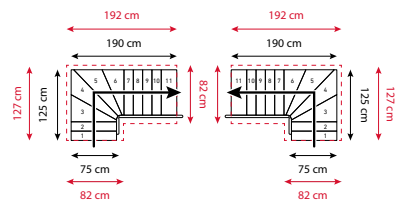
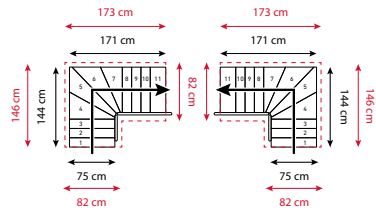
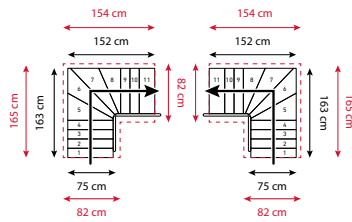
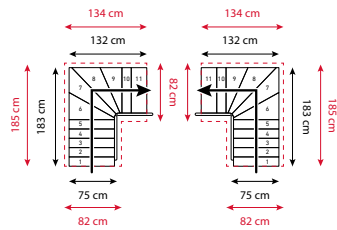
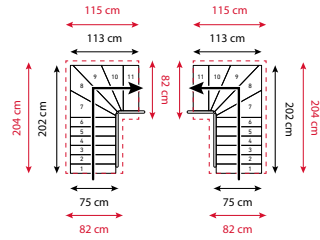
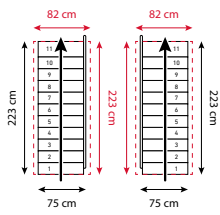

ALENA 11 STUFEN – BREITE 75 CM

H 222 - 258 cm

Treppenmaße inkl. einseitigem Designgeländer

Die Größe der Deckenöffnung in diesen Beispielen basiert auf den Annahmen: 2 cm Abstand zur Wand, 5 cm Abstand für die Hand, 19 cm Steigungshöhe, 25 cm Deckenstärke, 200 cm Kopfhöhe.

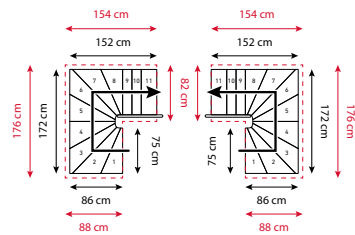
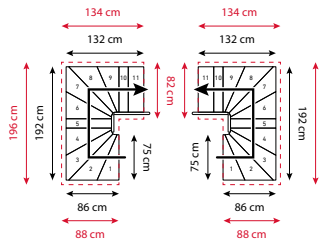
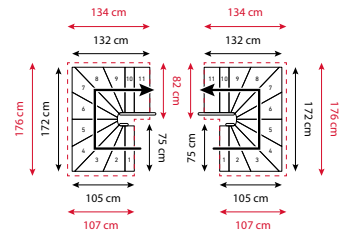
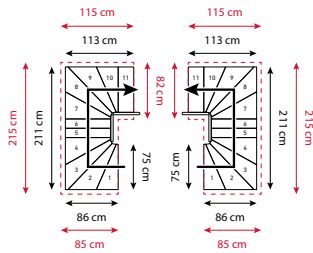
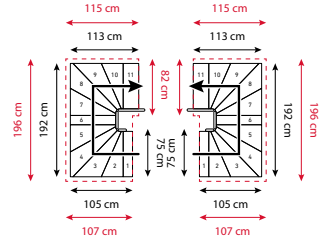
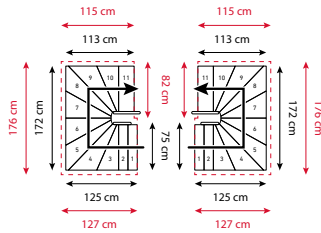

ALENA 12 STUFEN – BREITE 75 CM

H 240.5 - 279.5 cm

— Treppenmaße inkl. einseitigem Designgeländer

--- Die Größe der Deckenöffnung in diesen Beispielen basiert auf den Annahmen: 2 cm Abstand zur Wand, 5 cm Abstand für die Hand, 19 cm Steigungshöhe, 25 cm Deckenstärke, 200 cm Kopfhöhe.

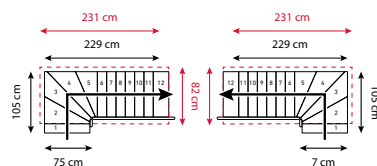
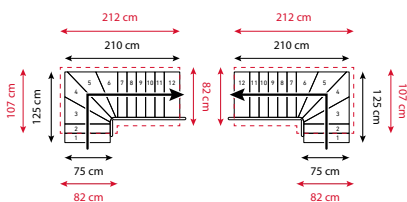
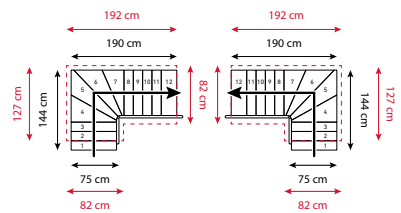
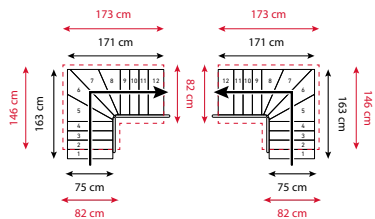
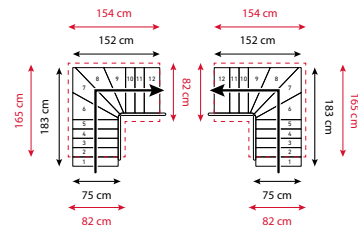
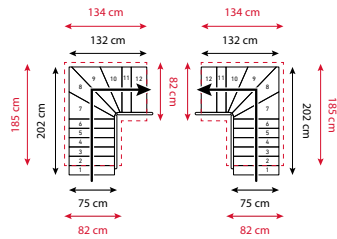
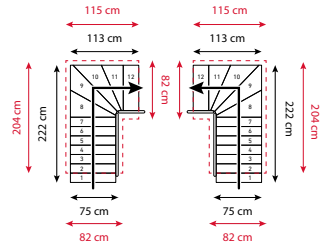
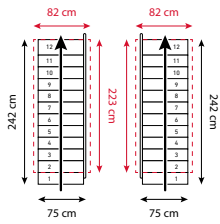

ALENA 12 STUFEN – BREITE 75 CM

H 240.5 - 279.5 cm

Treppenmaße inkl. einseitigem Designgeländer

Die Größe der Deckenöffnung in diesen Beispielen basiert auf den Annahmen: 2 cm Abstand zur Wand, 5 cm Abstand für die Hand, 19 cm Steigungshöhe, 25 cm Deckenstärke, 200 cm Kopfhöhe.

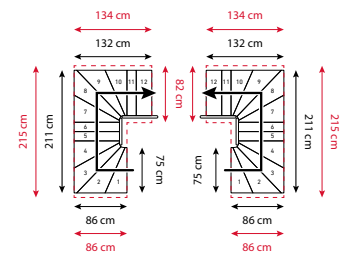
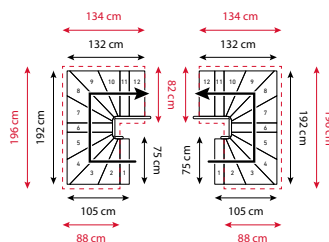
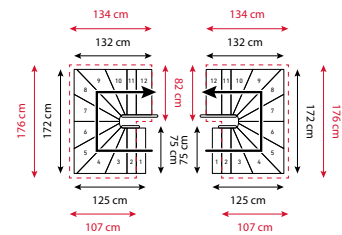
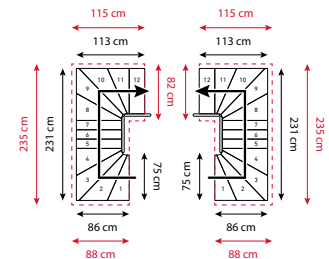
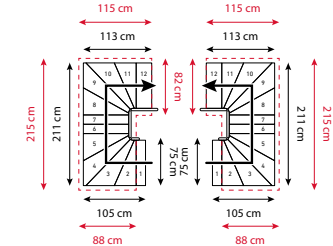
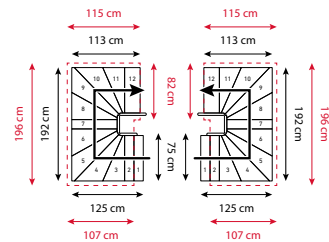
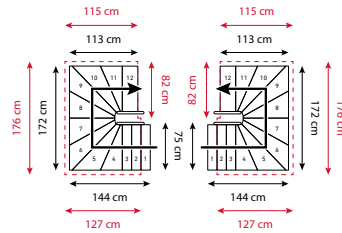
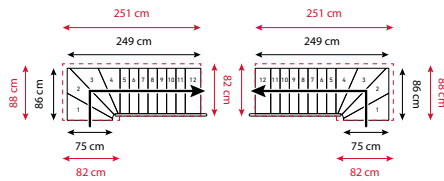

ALENA 12 STUFEN – BREITE 75 CM

H 240.5 - 279.5 cm

Treppenmaße inkl. einseitigem Designgeländer

--- Die Größe der Deckenöffnung in diesen Beispielen basiert auf den Annahmen: 2 cm Abstand zur Wand, 5 cm Abstand für die Hand, 19 cm Steigungshöhe, 25 cm Deckenstärke, 200 cm Kopfhöhe.

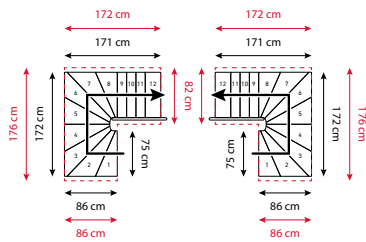
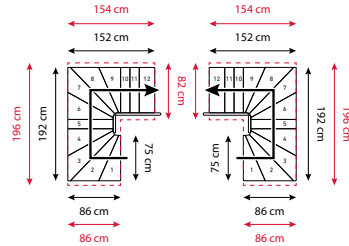
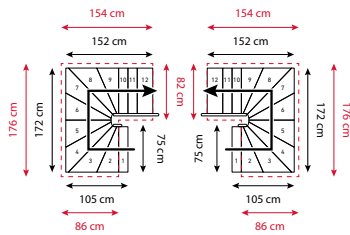

ALENA 13 STUFEN – BREITE 75 CM

H 259 - 301 cm

Treppenmaße inkl. einseitigem Designgeländer

--- Die Größe der Deckenöffnung in diesen Beispielen basiert auf den Annahmen: 2 cm Abstand zur Wand, 5 cm Abstand für die Hand, 19 cm Steigungshöhe, 25 cm Deckenstärke, 200 cm Kopfhöhe.

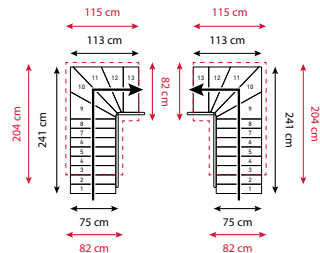
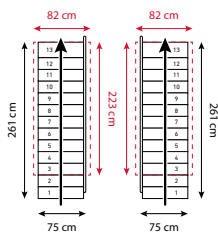

ALENA 13 STUFEN – BREITE 75 CM

H 259 - 301 cm

Treppenmaße inkl. einseitigem Designgeländer

Die Größe der Deckenöffnung in diesen Beispielen basiert auf den Annahmen: 2 cm Abstand zur Wand, 5 cm Abstand für die Hand, 19 cm Steigungshöhe, 25 cm Deckenstärke, 200 cm Kopfhöhe.

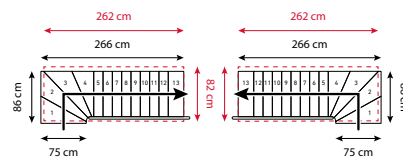
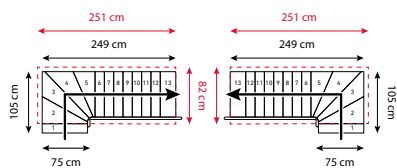
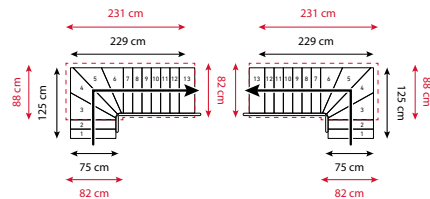
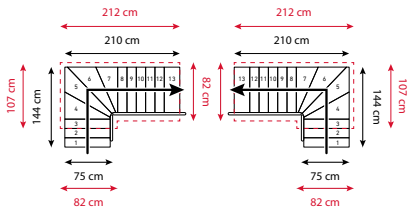
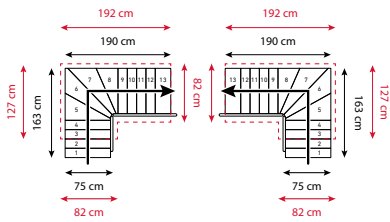
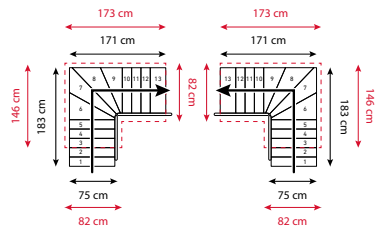
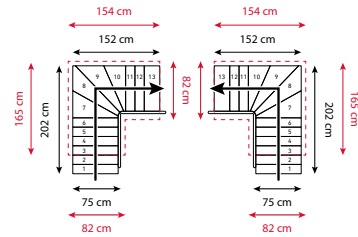
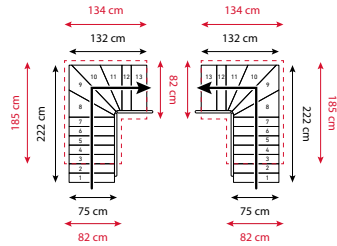

ALENA 13 STUFEN – BREITE 75 CM

H 259 - 301 cm

Treppenmaße inkl. einseitigem Designgeländer

Die Größe der Deckenöffnung in diesen Beispielen basiert auf den Annahmen: 2 cm Abstand zur Wand, 5 cm Abstand für die Hand, 19 cm Steigungshöhe, 25 cm Deckenstärke, 200 cm Kopfhöhe.

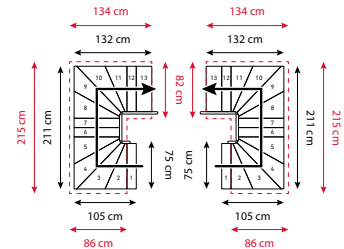
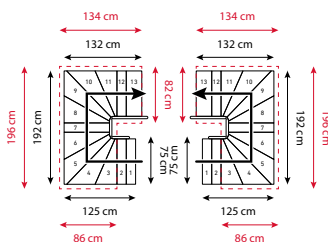
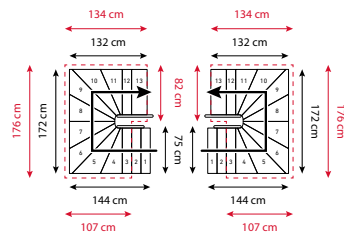
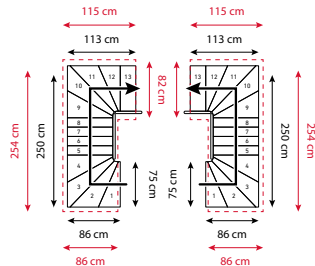
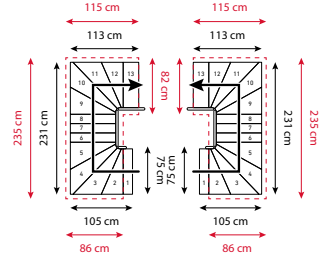
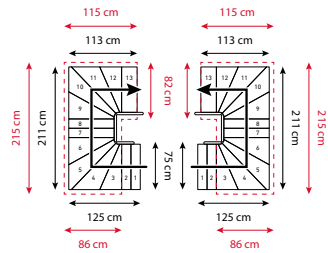
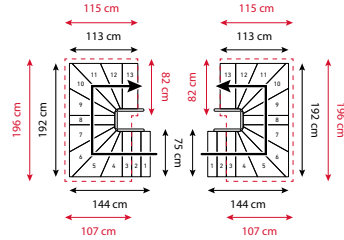
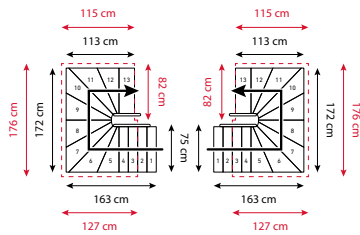

ALENA 13 STUFEN – BREITE 75 CM

H 259 - 301 cm

Treppenmaße inkl. einseitigem Designgeländer

Die Größe der Deckenöffnung in diesen Beispielen basiert auf den Annahmen: 2 cm Abstand zur Wand, 5 cm Abstand für die Hand, 19 cm Steigungshöhe, 25 cm Deckenstärke, 200 cm Kopfhöhe.

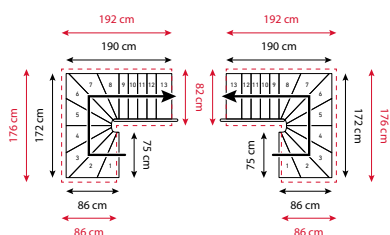
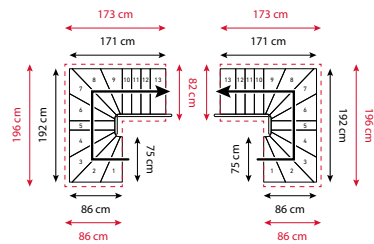
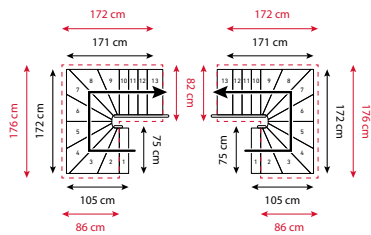
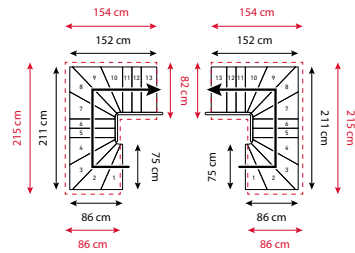
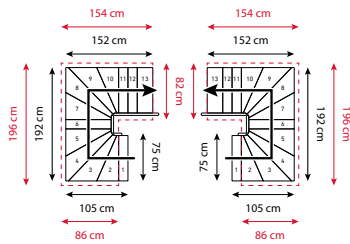
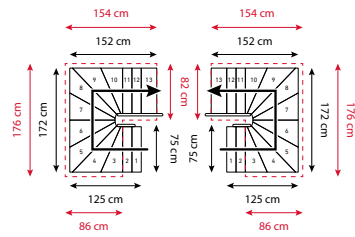
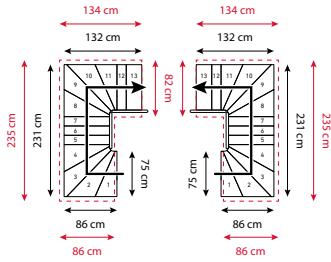

ALENA 14 STUFEN – BREITE 75 CM

H 277.5 - 322.5 cm

— Treppenmaße inkl. einseitigem Designgeländer

--- Die Größe der Deckenöffnung in diesen Beispielen basiert auf den Annahmen: 2 cm Abstand zur Wand, 5 cm Abstand für die Hand, 19 cm Steigungshöhe, 25 cm Deckenstärke, 200 cm Kopfhöhe.

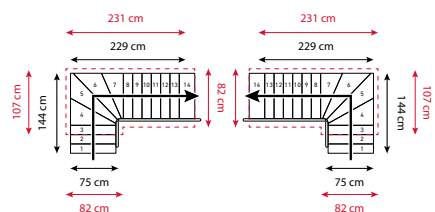
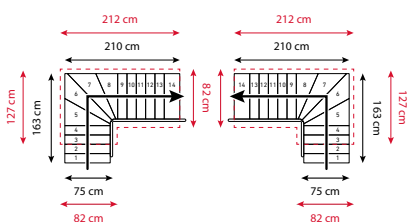
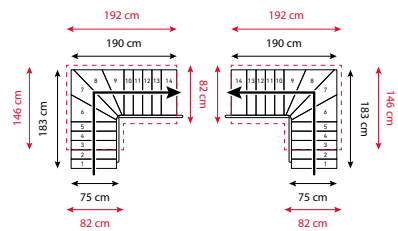
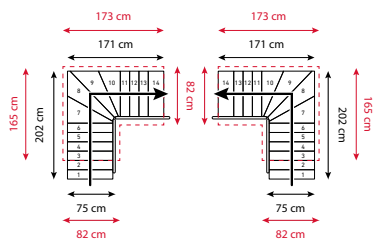
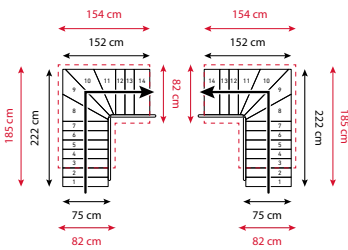
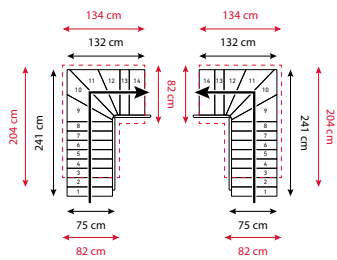
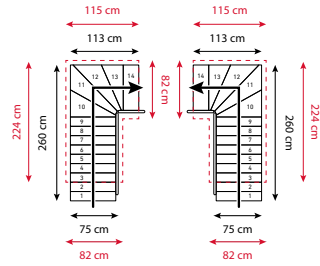
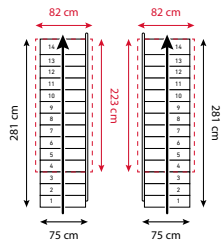

ALENA 14 STUFEN – BREITE 75 CM

H 277.5 - 322.5 cm

Treppenmaße inkl. einseitigem Designgeländer

Die Größe der Deckenöffnung in diesen Beispielen basiert auf den Annahmen: 2 cm Abstand zur Wand, 5 cm Abstand für die Hand, 19 cm Steigungshöhe, 25 cm Deckenstärke, 200 cm Kopfhöhe.

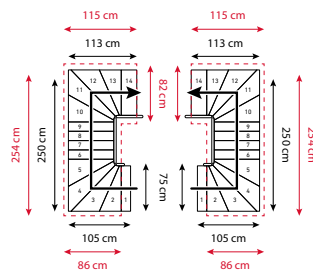
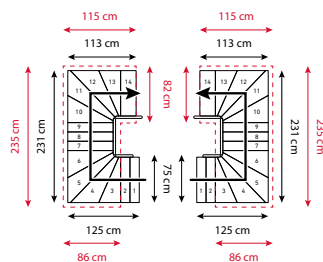
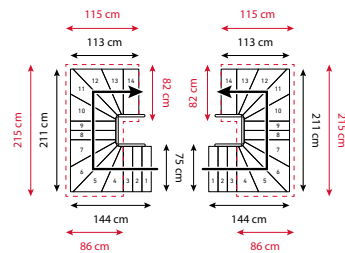
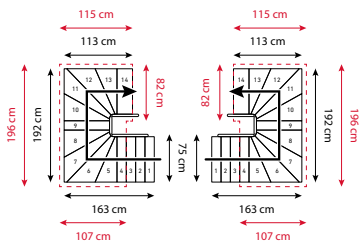
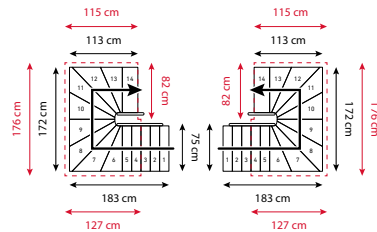
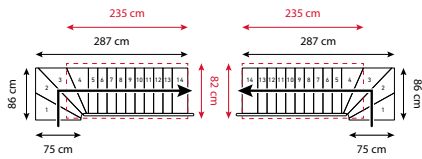
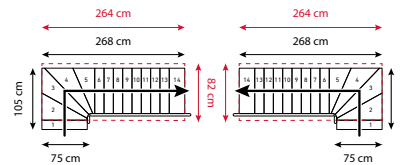
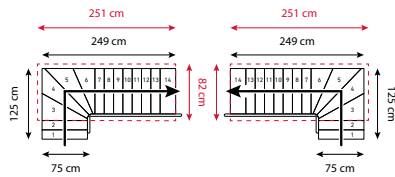

ALENA 14 STUFEN – BREITE 75 CM

H 277.5 - 322.5 cm

Treppenmaße inkl. einseitigem Designgeländer

Die Größe der Deckenöffnung in diesen Beispielen basiert auf den Annahmen: 2 cm Abstand zur Wand, 5 cm Abstand für die Hand, 19 cm Steigungshöhe, 25 cm Deckenstärke, 200 cm Kopfhöhe.

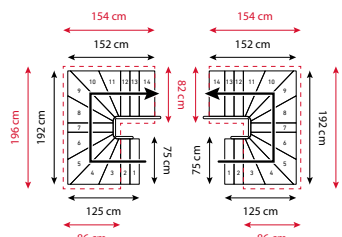
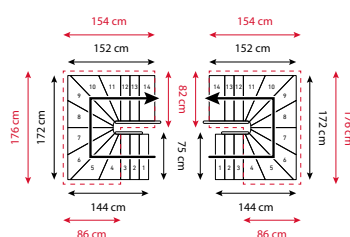
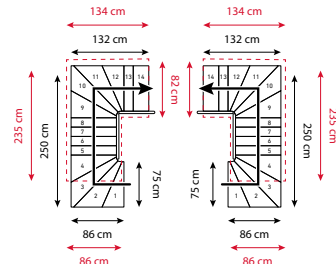
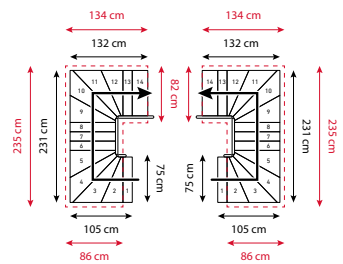
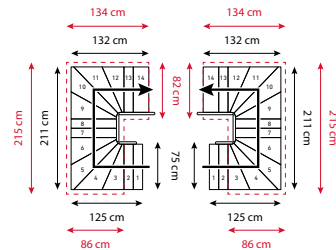
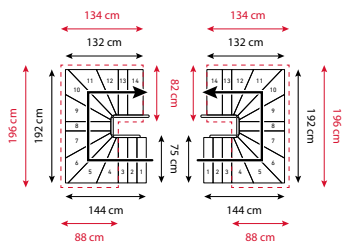
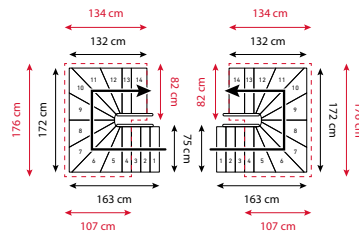
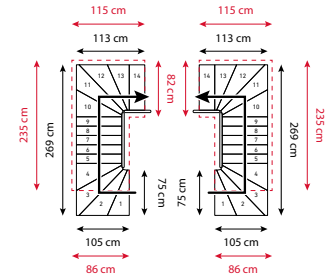

ALENA 14 STUFEN – BREITE 75 CM

H 277.5 - 322.5 cm

Treppenmaße inkl. einseitigem Designgeländer

Die Größe der Deckenöffnung in diesen Beispielen basiert auf den Annahmen: 2 cm Abstand zur Wand, 5 cm Abstand für die Hand, 19 cm Steigungshöhe, 25 cm Deckenstärke, 200 cm Kopfhöhe.

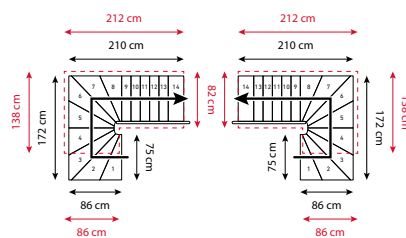
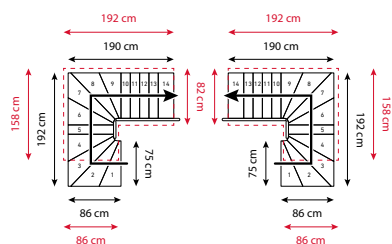
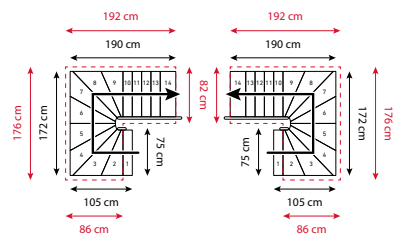
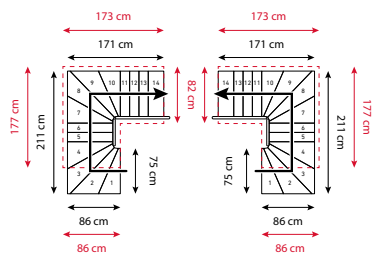
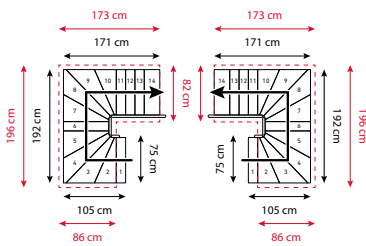
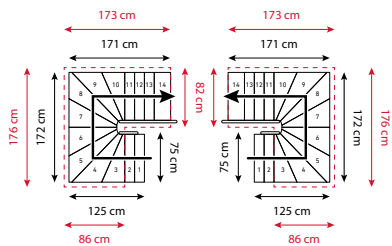
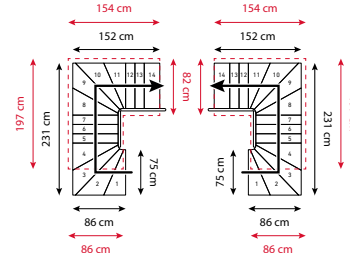
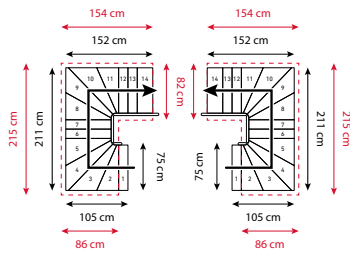

ALENA 11 STUFEN – BREITE 85 CM

H 222 - 258 cm

Treppenmaße inkl. einseitigem Designgeländer

Die Größe der Deckenöffnung in diesen Beispielen basiert auf den Annahmen: 2 cm Abstand zur Wand, 5 cm Abstand für die Hand, 19 cm Steigungshöhe, 25 cm Deckenstärke, 200 cm Kopfhöhe.

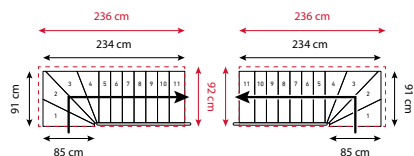
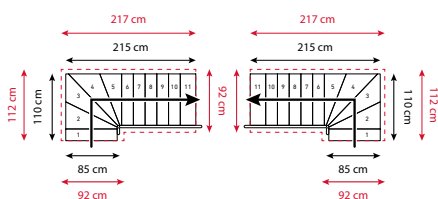
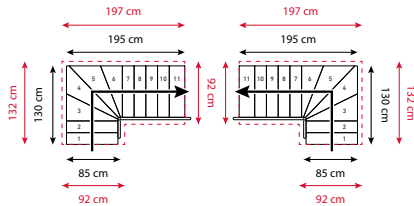
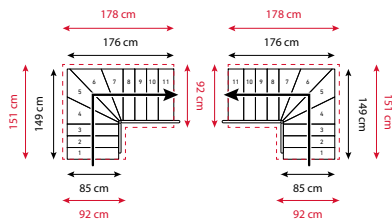
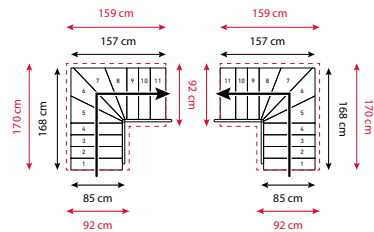
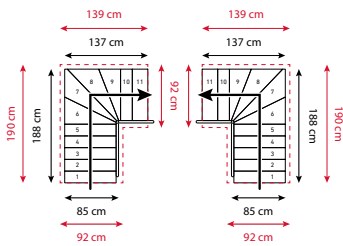
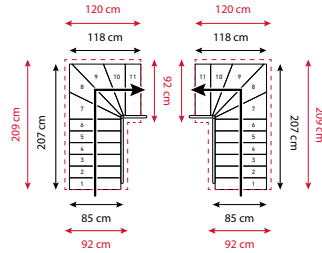
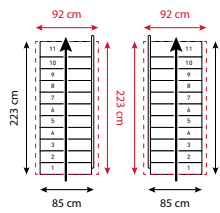

ALENA 11 STUFEN – BREITE 85 CM

H 222 - 258 cm

Treppenmaße inkl. einseitigem Designgeländer

Die Größe der Deckenöffnung in diesen Beispielen basiert auf den Annahmen: 2 cm Abstand zur Wand, 5 cm Abstand für die Hand, 19 cm Steigungshöhe, 25 cm Deckenstärke, 200 cm Kopfhöhe.

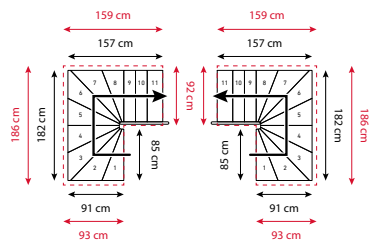
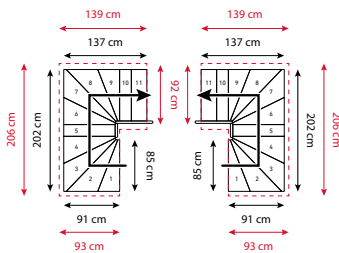
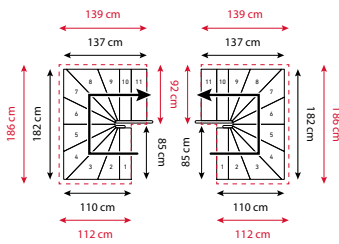
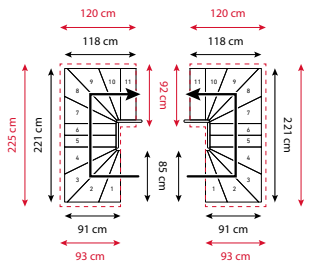
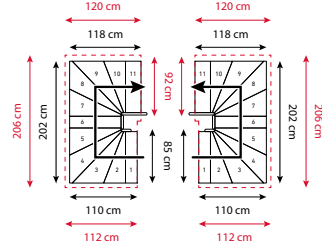
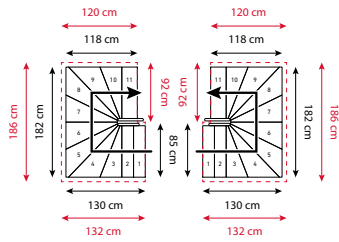

ALENA 12 STUFEN – BREITE 85 CM

H 240.5 - 279.5 cm

Treppenmaße inkl. einseitigem Designgeländer

Die Größe der Deckenöffnung in diesen Beispielen basiert auf den Annahmen: 2 cm Abstand zur Wand, 5 cm Abstand für die Hand, 19 cm Steigungshöhe, 25 cm Deckenstärke, 200 cm Kopfhöhe.

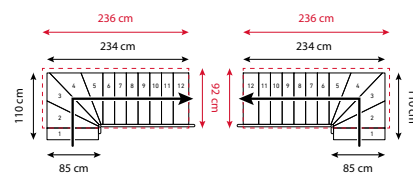
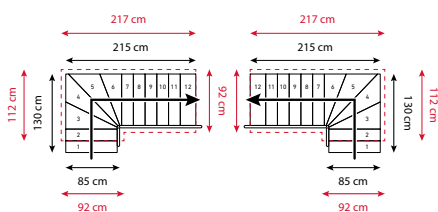
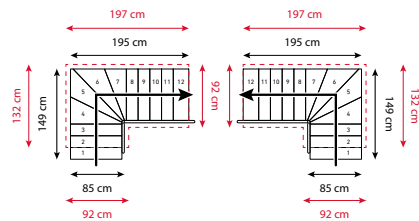
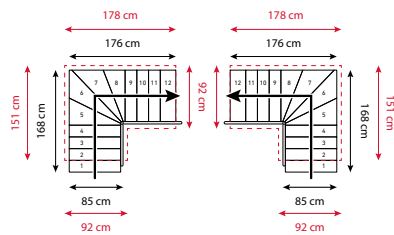
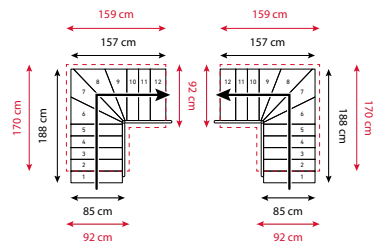
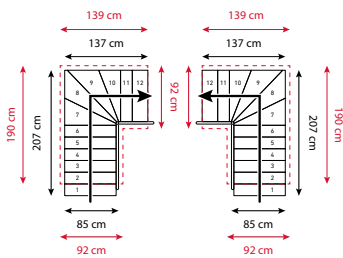
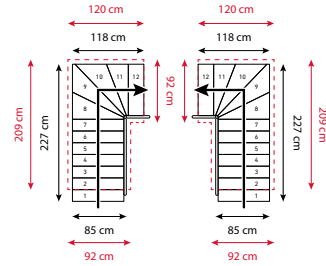
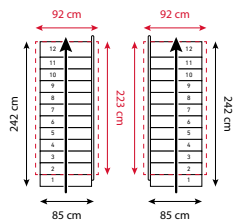

ALENA 12 STUFEN – BREITE 85 CM

H 240.5 - 279.5 cm

Treppenmaße inkl. einseitigem Designgeländer

Die Größe der Deckenöffnung in diesen Beispielen basiert auf den Annahmen: 2 cm Abstand zur Wand, 5 cm Abstand für die Hand, 19 cm Steigungshöhe, 25 cm Deckenstärke, 200 cm Kopfhöhe.

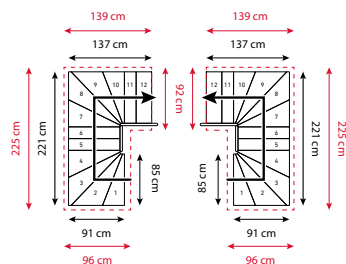
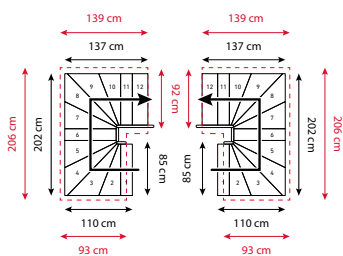
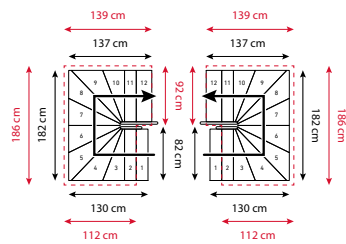
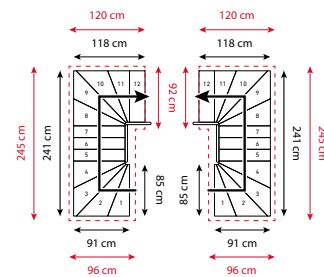
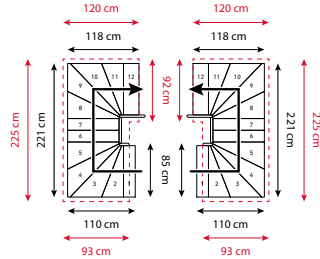
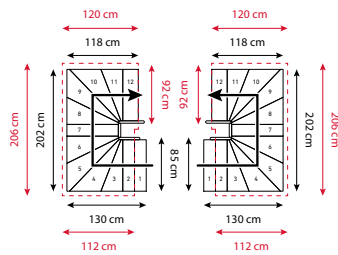
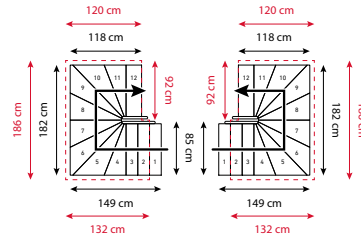
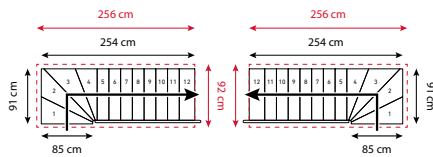

ALENA 12 STUFEN – BREITE 85 CM

H 240.5 - 279.5 cm

— Treppenmaße inkl. einseitigem Designgeländer

--- Die Größe der Deckenöffnung in diesen Beispielen basiert auf den Annahmen: 2 cm Abstand zur Wand, 5 cm Abstand für die Hand, 19 cm Steigungshöhe, 25 cm Deckenstärke, 200 cm Kopfhöhe.

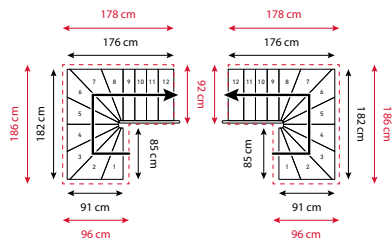
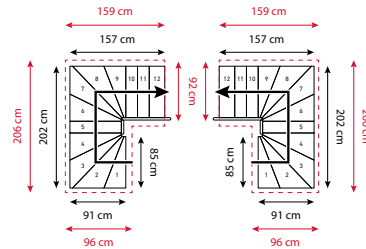
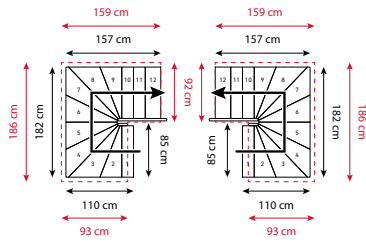

ALENA 13 STUFEN – BREITE 85 CM

H 259 - 301 cm

— Treppenmaße inkl. einseitigem Designgeländer

--- Die Größe der Deckenöffnung in diesen Beispielen basiert auf den Annahmen: 2 cm Abstand zur Wand, 5 cm Abstand für die Hand, 19 cm Steigungshöhe, 25 cm Deckenstärke, 200 cm Kopfhöhe.

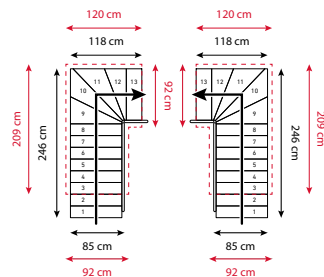
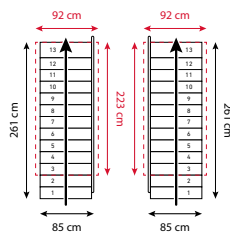

ALENA 13 STUFEN – BREITE 85 CM

H 259 - 301 cm

Treppenmaße inkl. einseitigem Designgeländer

Die Größe der Deckenöffnung in diesen Beispielen basiert auf den Annahmen: 2 cm Abstand zur Wand, 5 cm Abstand für die Hand, 19 cm Steigungshöhe, 25 cm Deckenstärke, 200 cm Kopfhöhe.

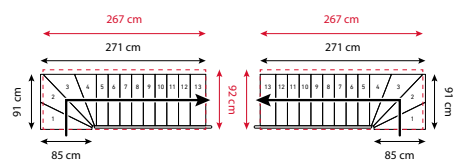
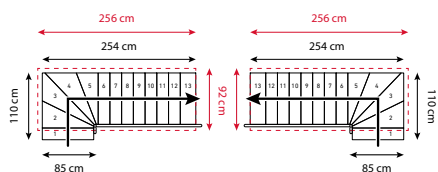
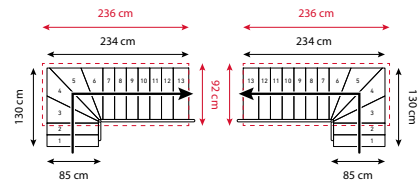
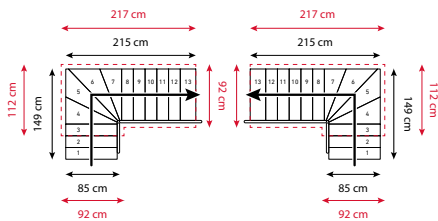
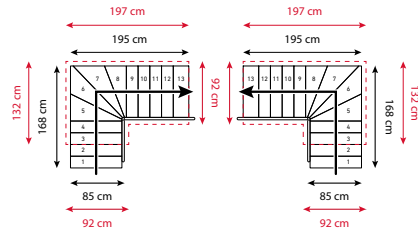
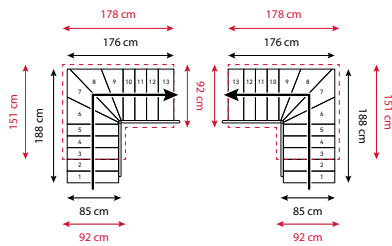
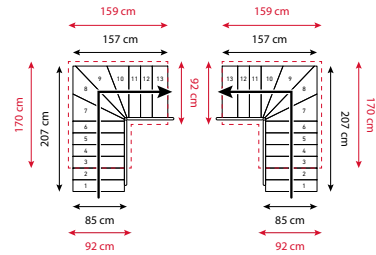
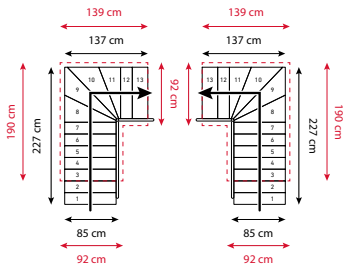

ALENA 13 STUFEN – BREITE 85 CM

H 259 - 301 cm

Treppenmaße inkl. einseitigem Designgeländer

Die Größe der Deckenöffnung in diesen Beispielen basiert auf den Annahmen: 2 cm Abstand zur Wand, 5 cm Abstand für die Hand, 19 cm Steigungshöhe, 25 cm Deckenstärke, 200 cm Kopfhöhe.

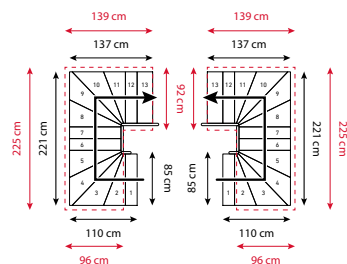
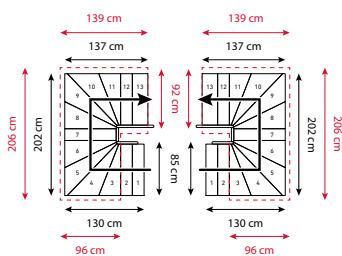
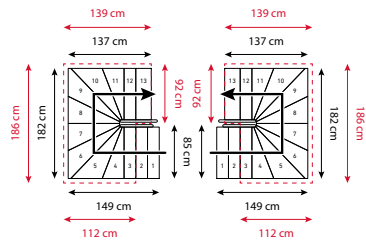
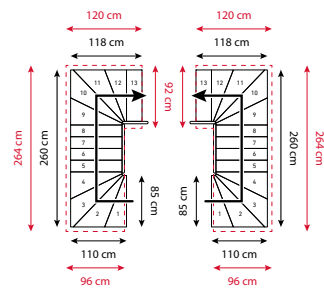
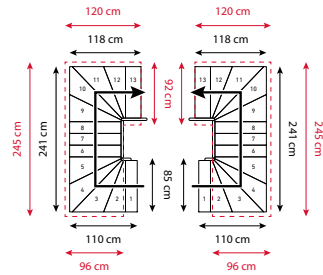
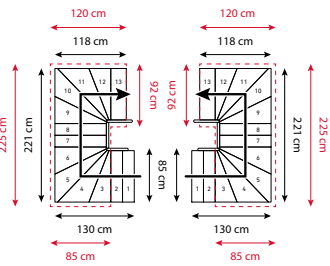
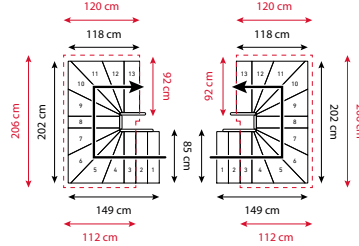
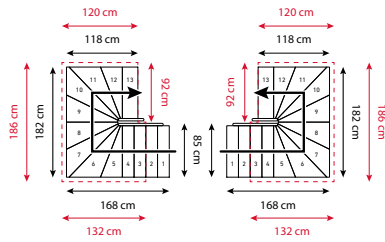

ALENA 13 STUFEN – BREITE 85 CM

H 259 - 301 cm

Treppenmaße inkl. einseitigem Designgeländer

Die Größe der Deckenöffnung in diesen Beispielen basiert auf den Annahmen: 2 cm Abstand zur Wand, 5 cm Abstand für die Hand, 19 cm Steigungshöhe, 25 cm Deckenstärke, 200 cm Kopfhöhe.

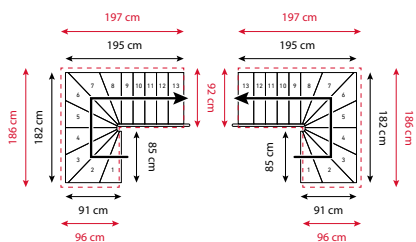
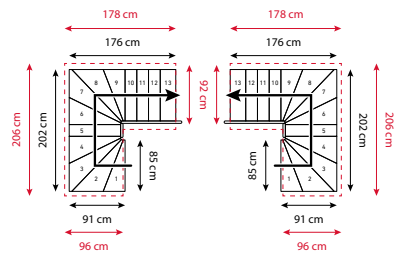
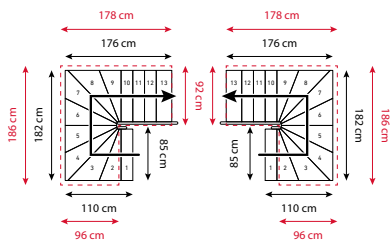
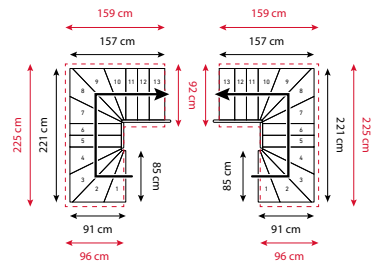
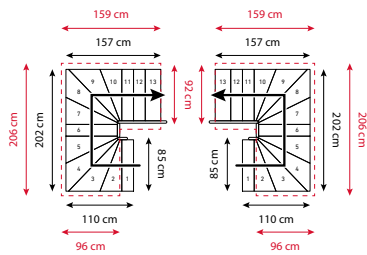
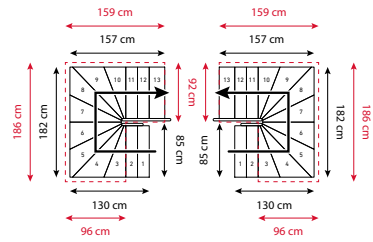
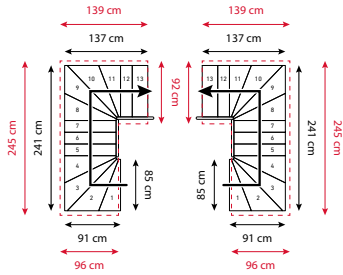

ALENA 14 STUFEN – BREITE 85 CM

H 277.5 - 322.5 cm

Treppenmaße inkl. einseitigem Designgeländer

Die Größe der Deckenöffnung in diesen Beispielen basiert auf den Annahmen: 2 cm Abstand zur Wand, 5 cm Abstand für die Hand, 19 cm Steigungshöhe, 25 cm Deckenstärke, 200 cm Kopfhöhe.

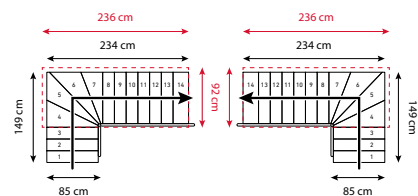
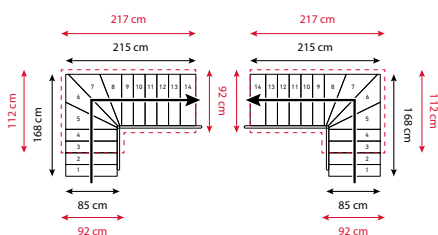
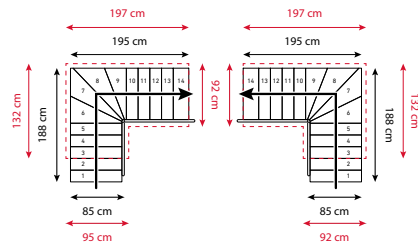
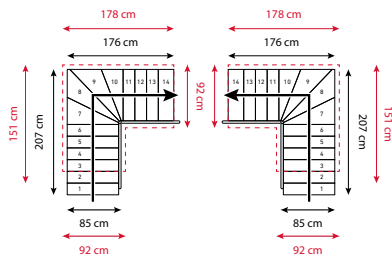
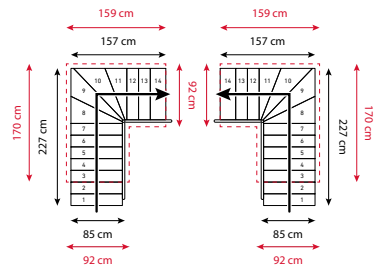
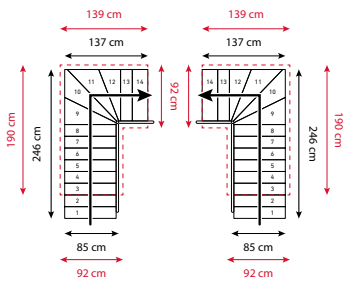
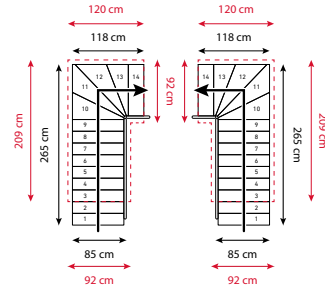
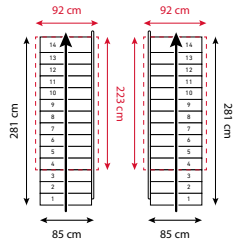

ALENA 14 STUFEN – BREITE 85 CM

H 277.5 - 322.5 cm

Treppenmaße inkl. einseitigem Designgeländer

Die Größe der Deckenöffnung in diesen Beispielen basiert auf den Annahmen: 2 cm Abstand zur Wand, 5 cm Abstand für die Hand, 19 cm Steigungshöhe, 25 cm Deckenstärke, 200 cm Kopfhöhe.

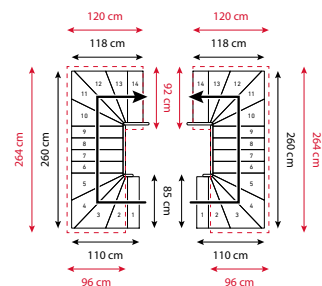
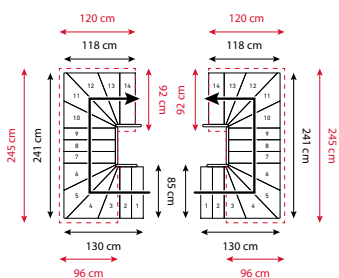
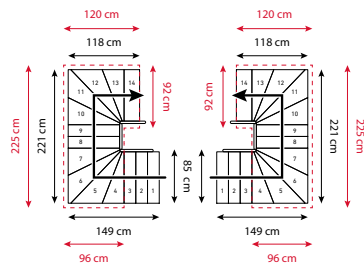
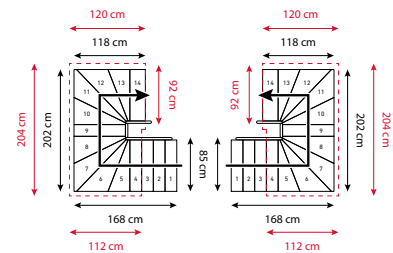
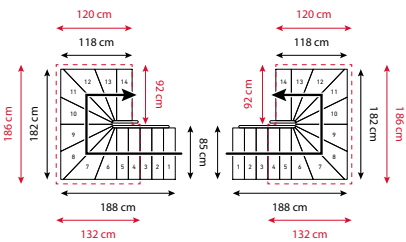
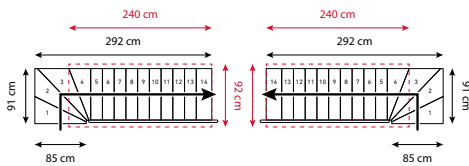
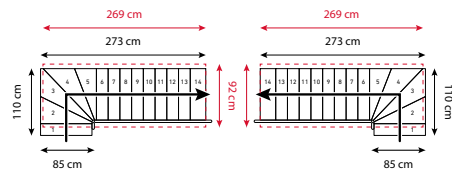
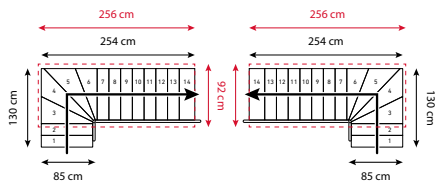

ALENA 14 STUFEN – BREITE 85 CM

H 277.5 - 322.5 cm

Treppenmaße inkl. einseitigem Designgeländer

Die Größe der Deckenöffnung in diesen Beispielen basiert auf den Annahmen: 2 cm Abstand zur Wand, 5 cm Abstand für die Hand, 19 cm Steigungshöhe, 25 cm Deckenstärke, 200 cm Kopfhöhe.

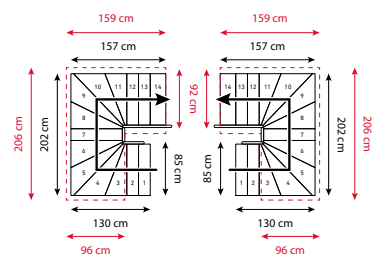
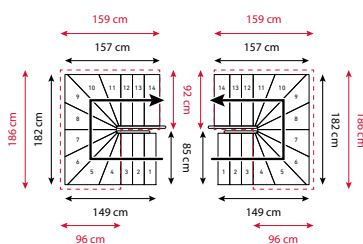
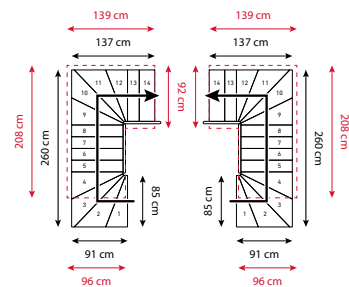
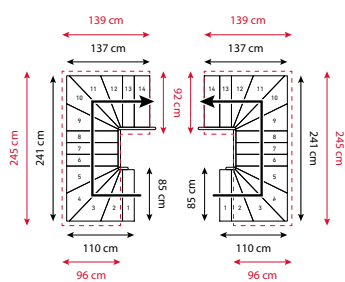
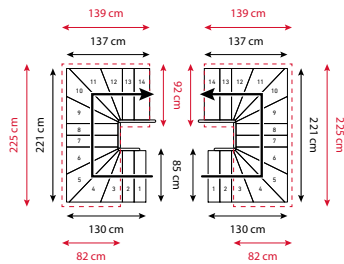
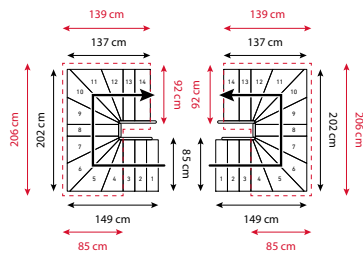
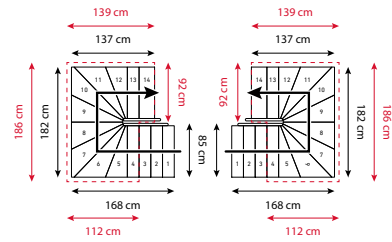
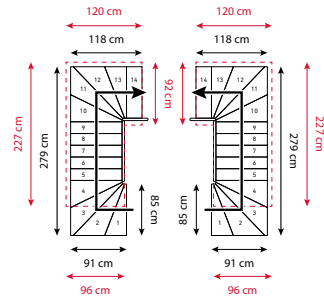

ALENA 14 STUFEN – BREITE 85 CM

H 277.5 - 322.5 cm

Treppenmaße inkl. einseitigem Designgeländer

Die Größe der Deckenöffnung in diesen Beispielen basiert auf den Annahmen: 2 cm Abstand zur Wand, 5 cm Abstand für die Hand, 19 cm Steigungshöhe, 25 cm Deckenstärke, 200 cm Kopfhöhe.

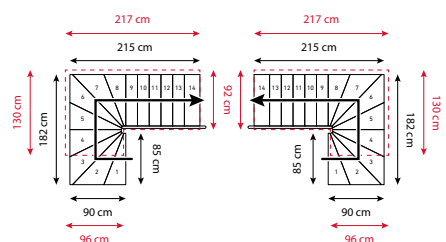
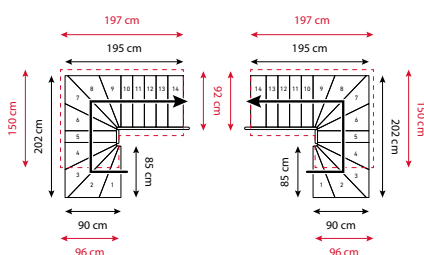
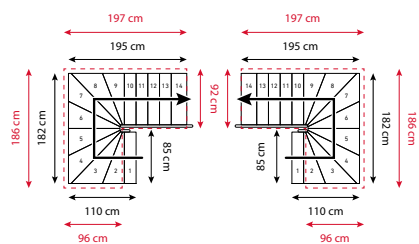
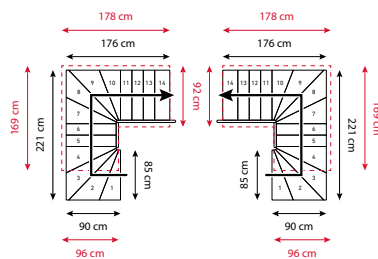
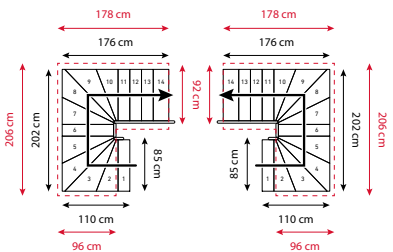
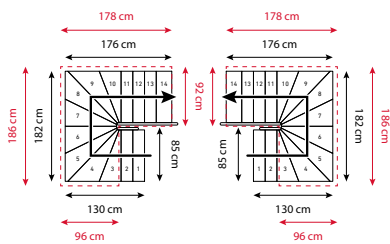
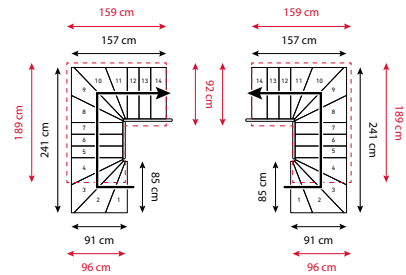
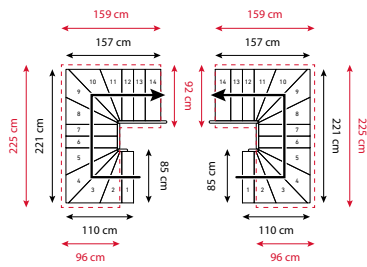

ALENA 1/4-GEWENDELT

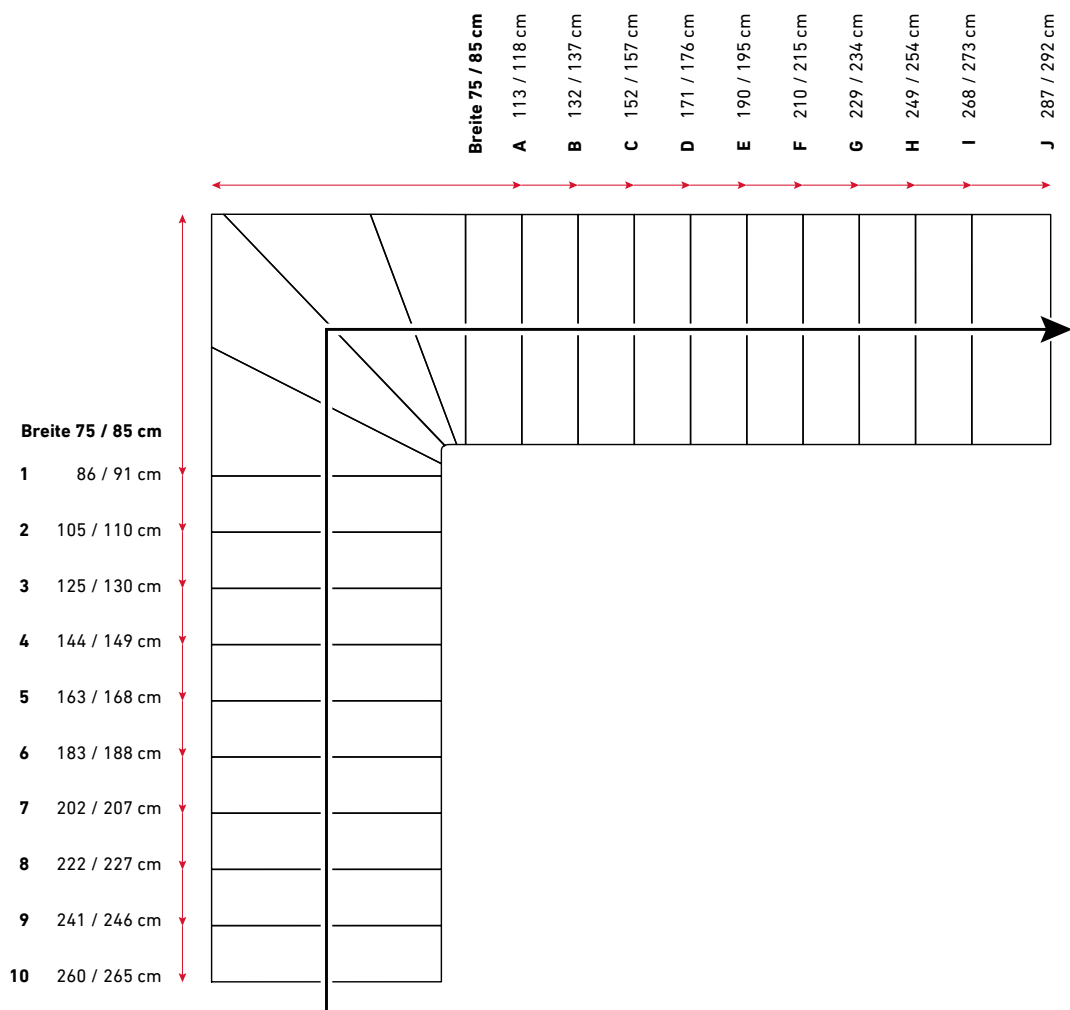

ALENA 1/2-GEWENDELT

